

$3^2 + 4^2 = 5^2$ di Sam Loyd

Disegni di F. Decio

Preparazione fogli

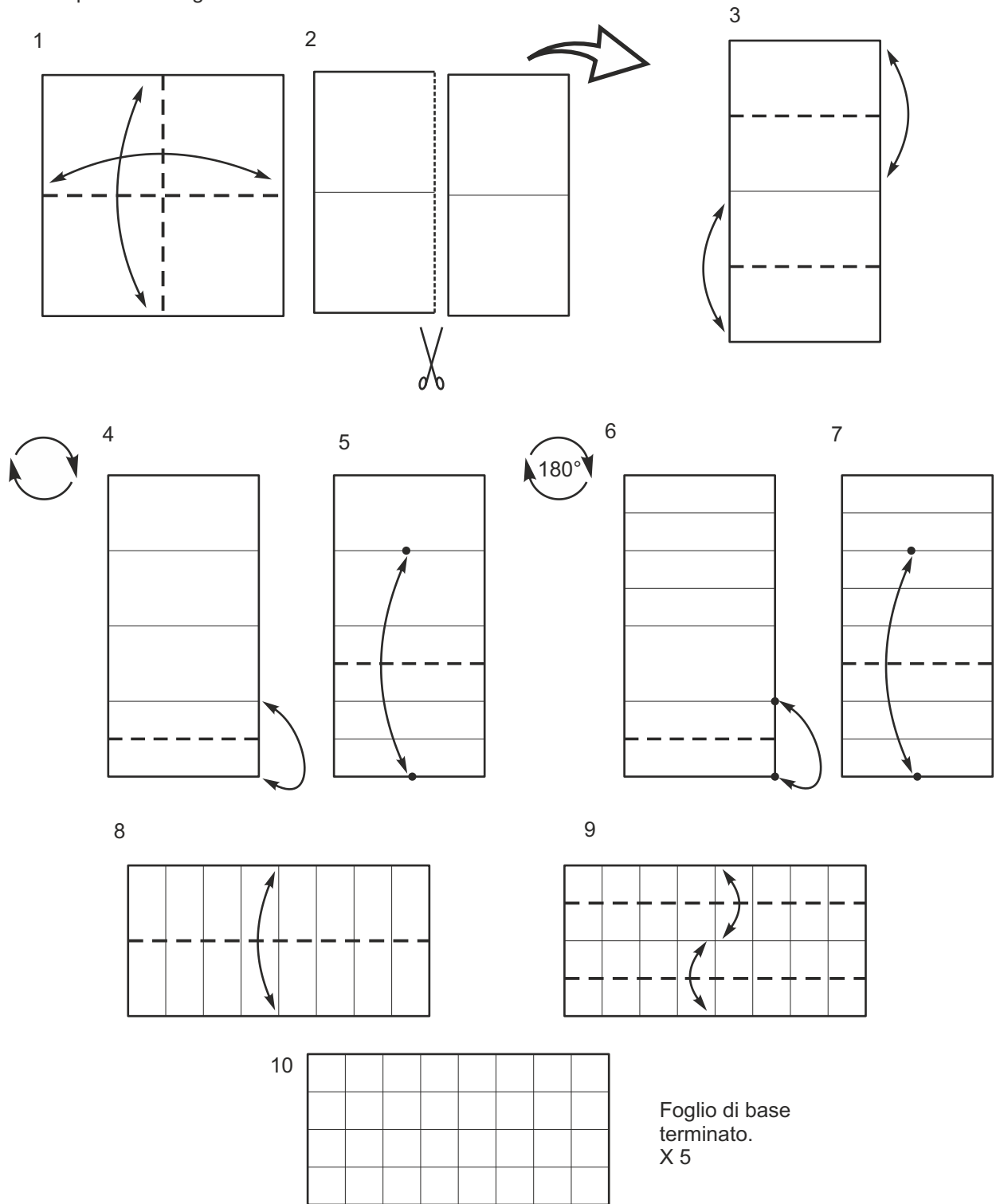

Pezzo A

1

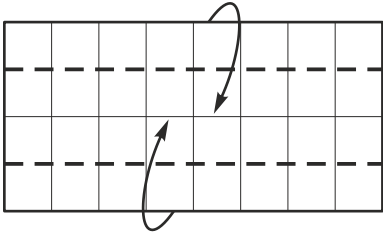

2

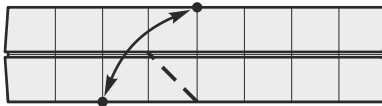

3



4

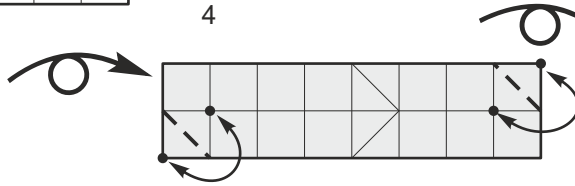

5

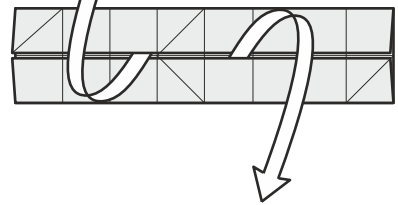

6

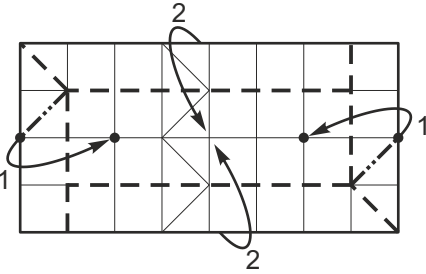

6 A (in progressione)

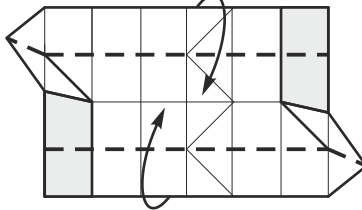

7

3 D

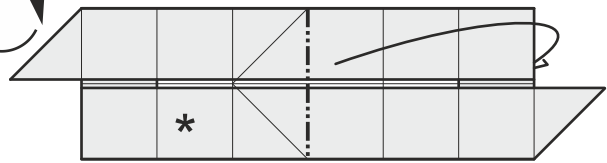

8

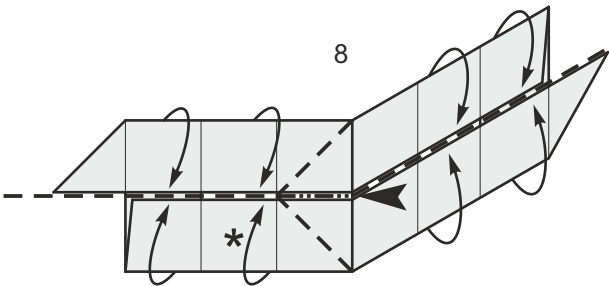

Estrarre lo strato segnato *

9

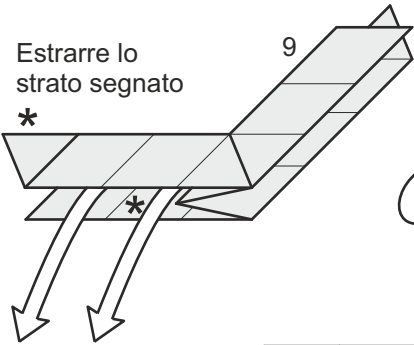

10

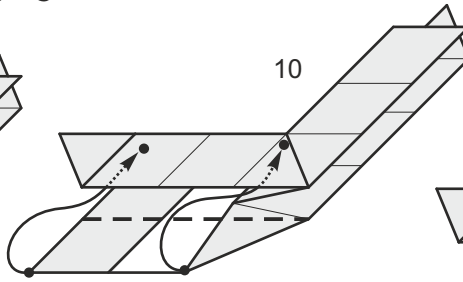

11

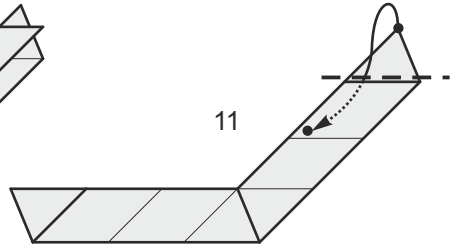

12

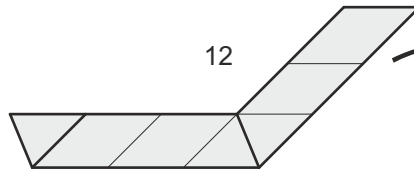

13

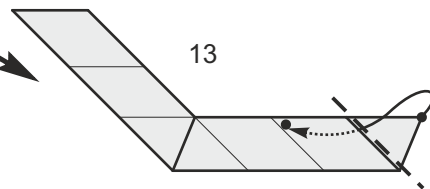

14

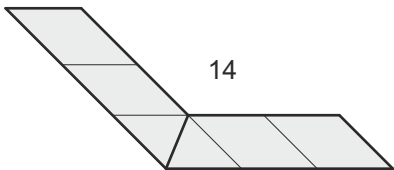

15

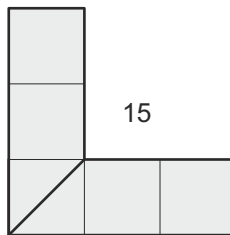

Pezzo A
terminato.
X 2

Pezzo B

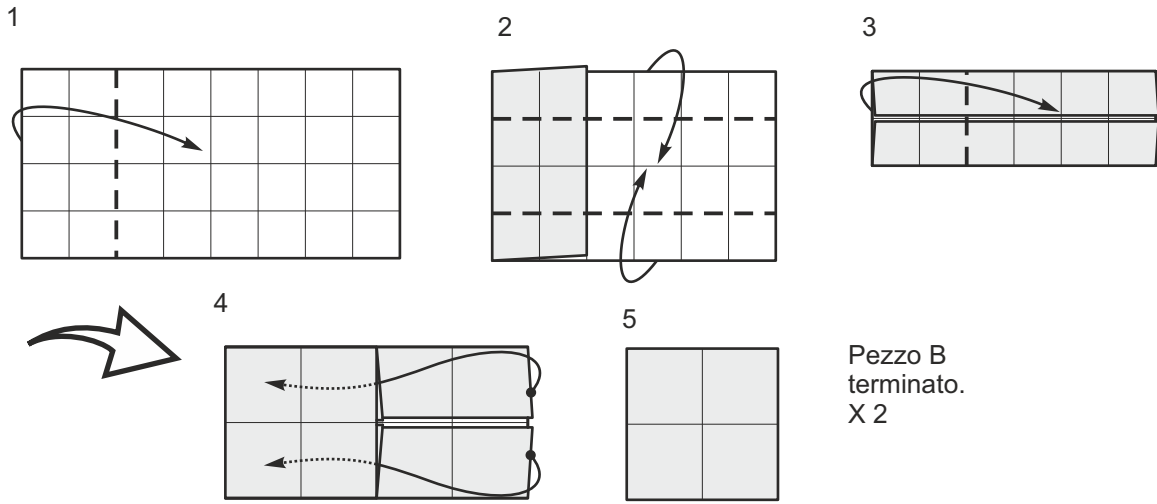

Pezzo C

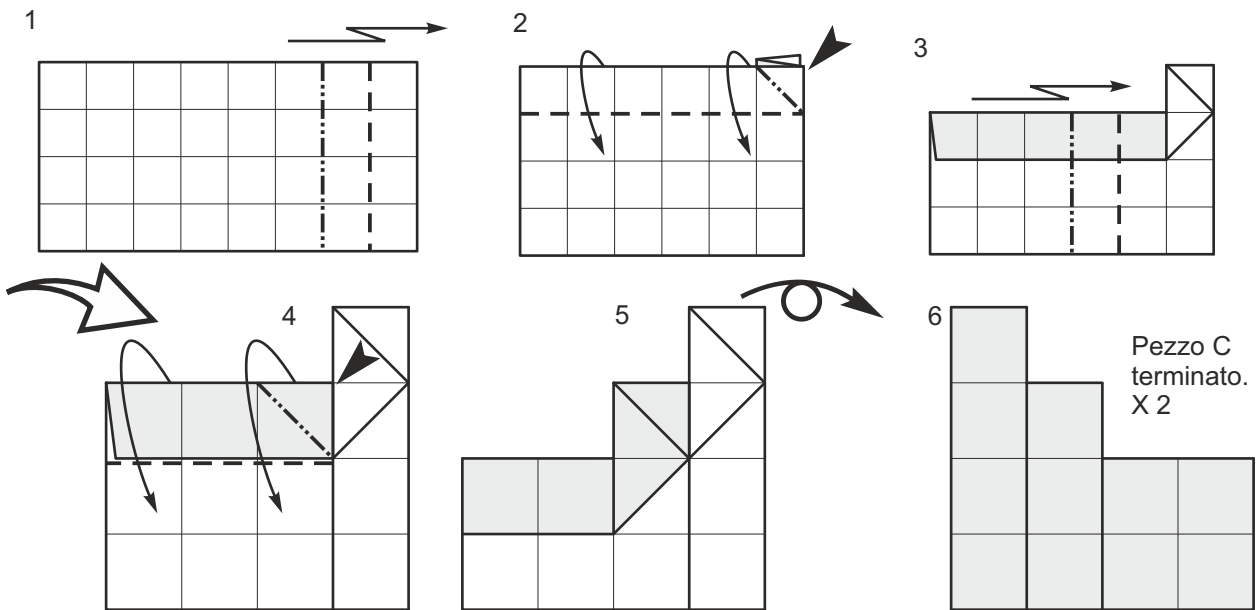

Pezzo D

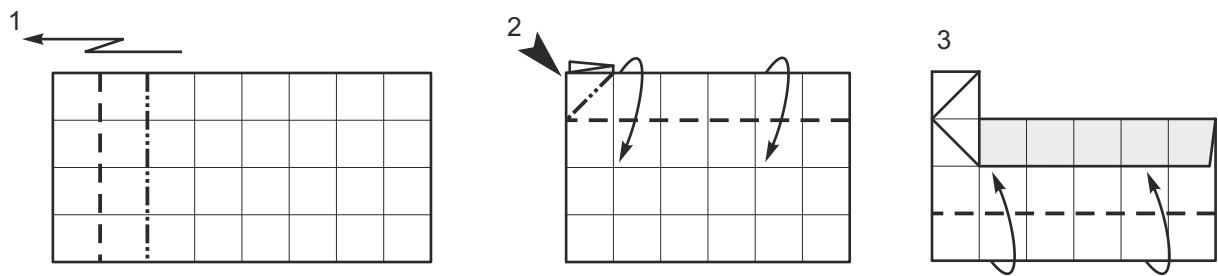

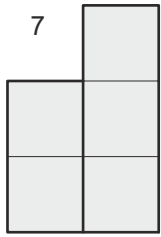
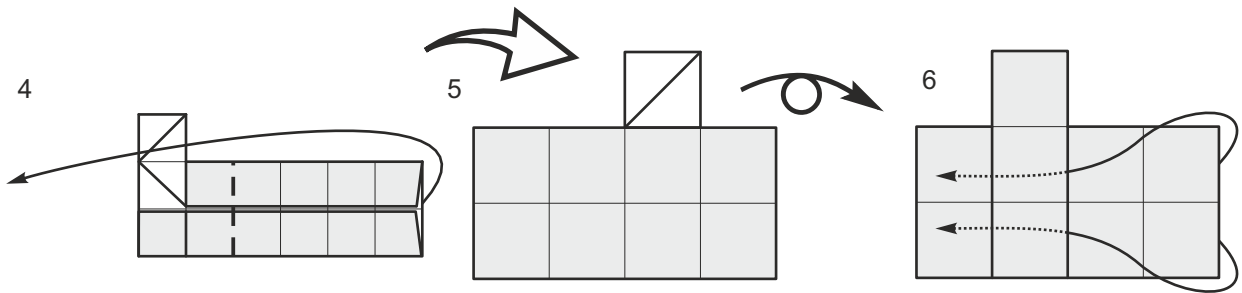

Pezzo D
terminato.
X 2

Triangolo rettangolo

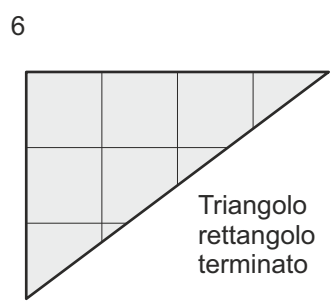
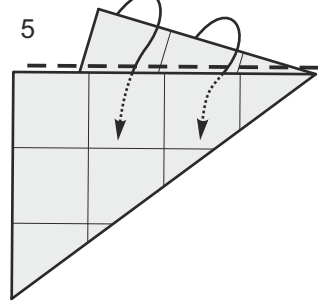
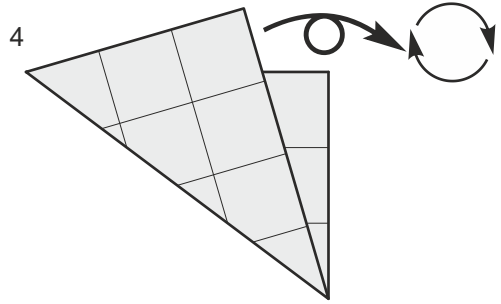
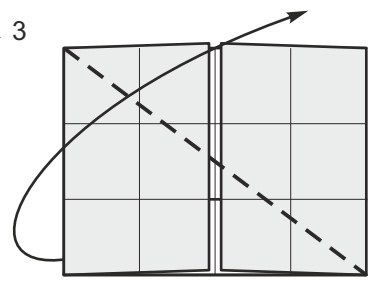
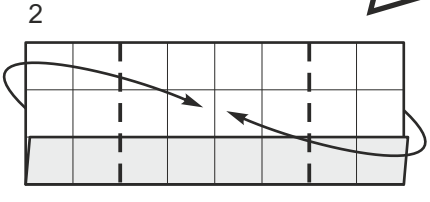
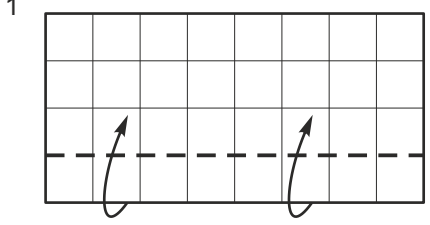

Triangolo
rettangolo
terminato

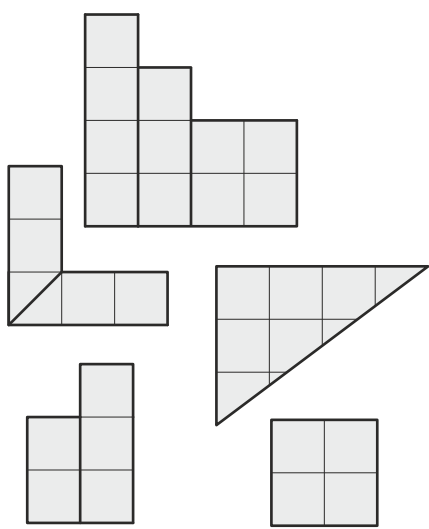

=

