

Tessera triangolare

Tessere triangolari e quadrate

Di Francesco Decio

1

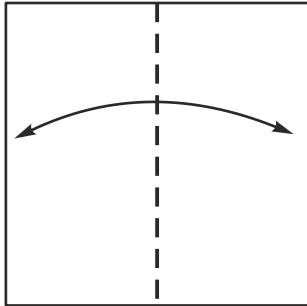

2

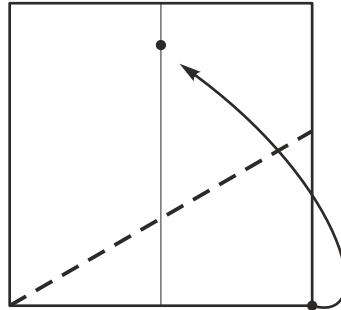

3

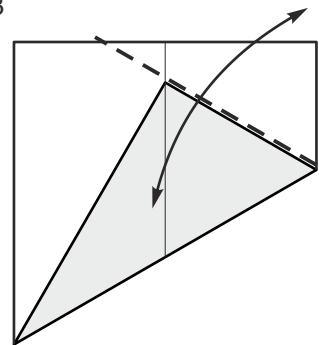

4

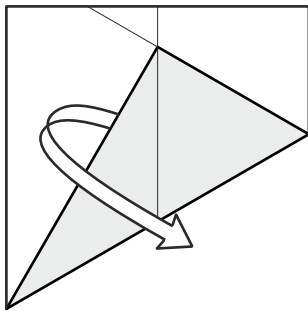

5

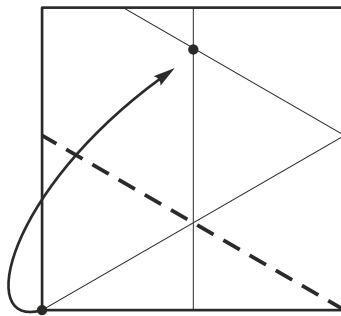

6

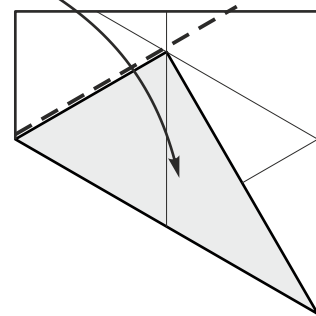

7

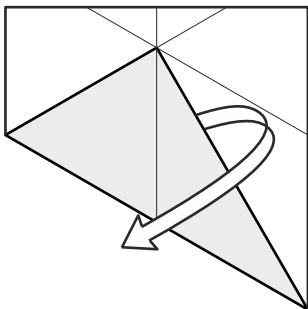

8

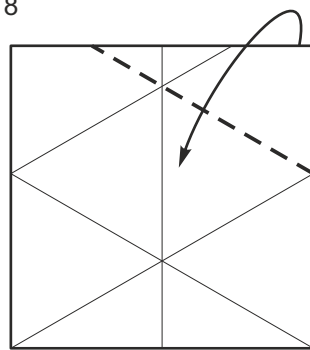

9

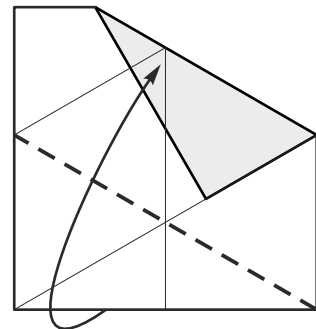

10

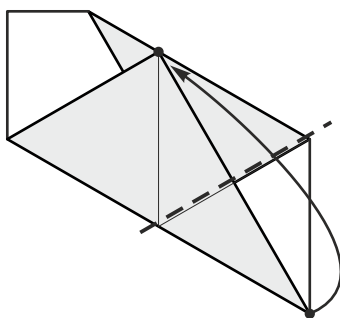

11

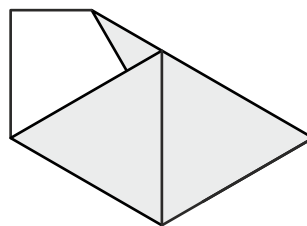

12

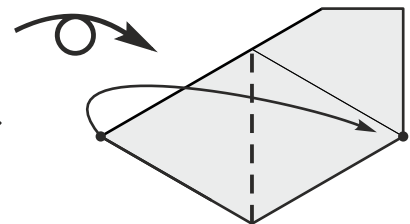

13

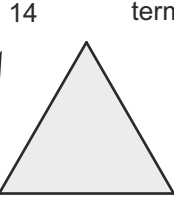
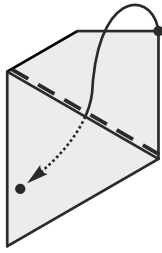

Tessera triangolare a tre tasche terminata.

Giunti per unire le tessere triangolari

15

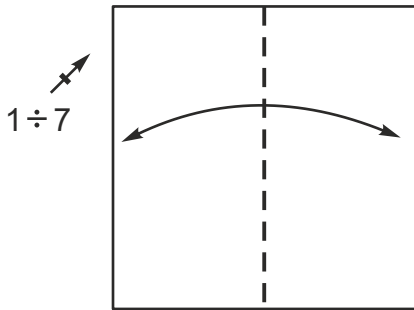

16

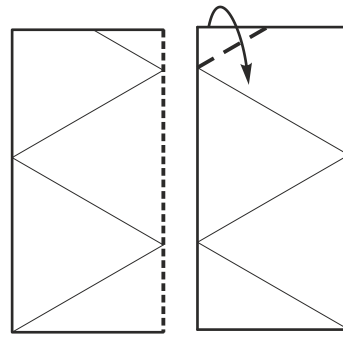

17

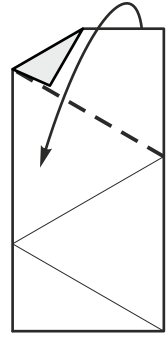

18

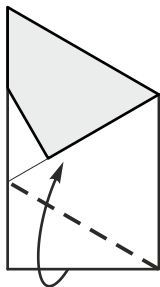

19

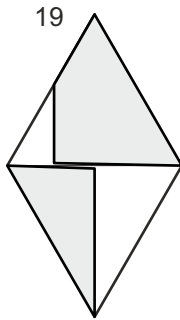

Giunto terminato



Tessera quadrata di lato compatibile con tessera triangolare

20

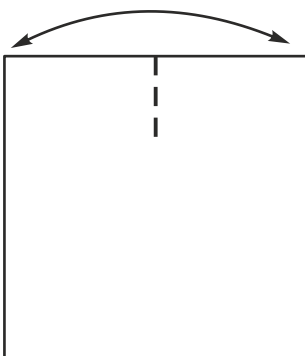

21

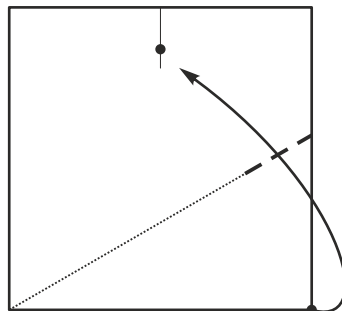

22

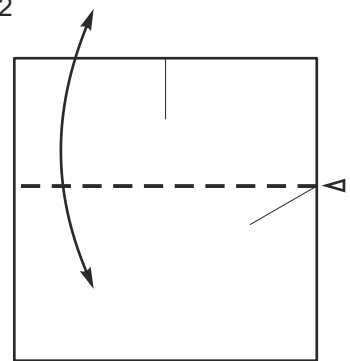

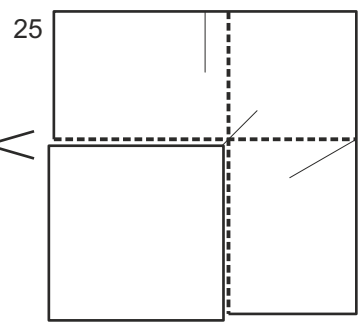
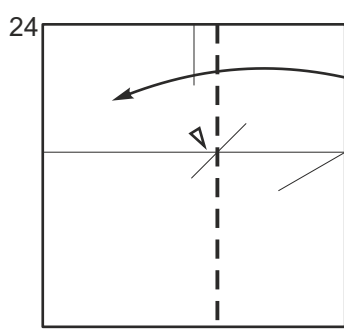
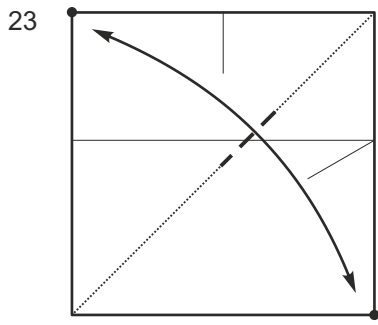

Tessera quadrata a 4 tasche

Primo pezzo

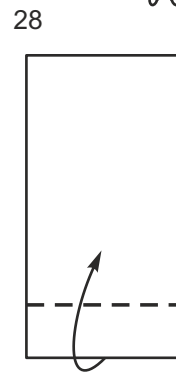
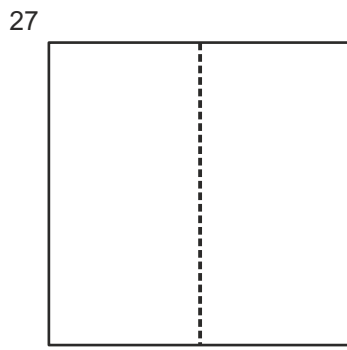
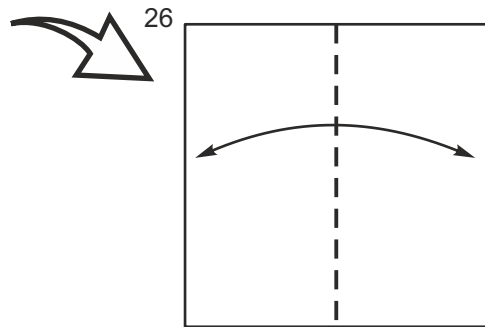

Piegare il lato inferiore con lunghezza a piacere

29 Piegare il lato superiore portando a combaciare i punti indicati

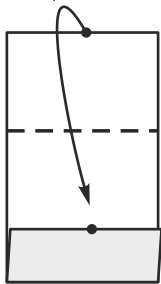

30 Primo pezzo della tessera terminato



Secondo pezzo

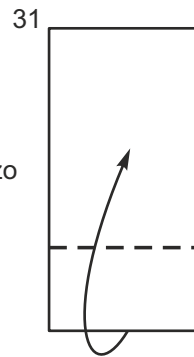

32 Piegare il lato superiore portando a combaciare i punti indicati

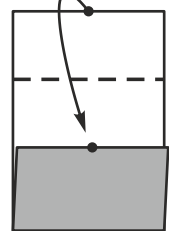

33 Riaprire tutto il foglio

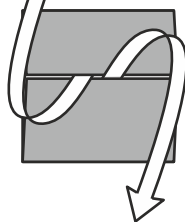

34

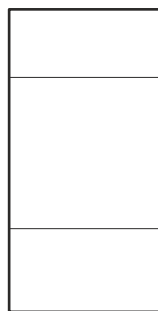

Ruotare il foglio di 90 gradi



35 Secondo pezzo della tessera terminato

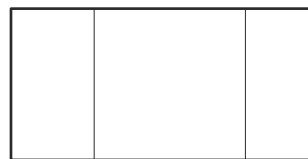

36
Inserire il secondo pezzo nel primo facendo coincidere i punti indicati

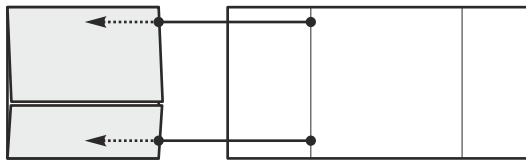

37
Inserire l'estremità destra del secondo pezzo nella tasca del primo

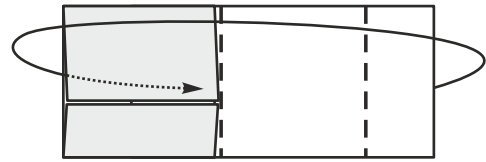

38
La tessera quadrata con quattro tasche terminata

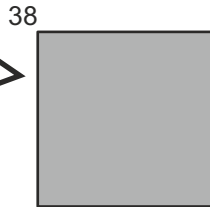

39



La tessera quadrata con quattro tasche terminata e vista da sotto

Giunti per unire tessere quadrate e / o triangolari tra loro.

40

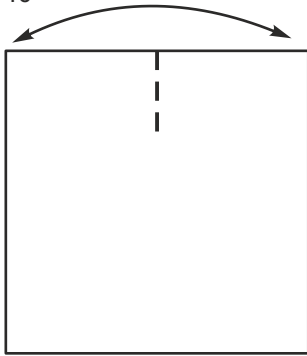

41

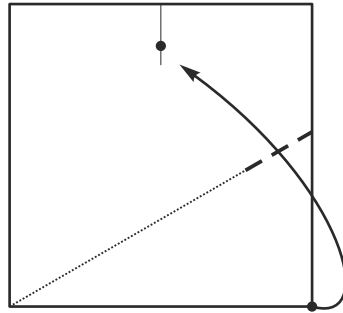

42

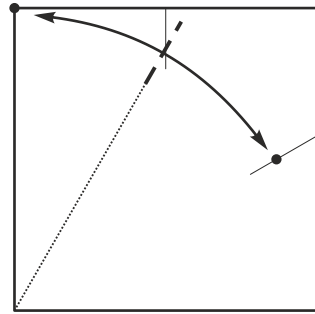

43

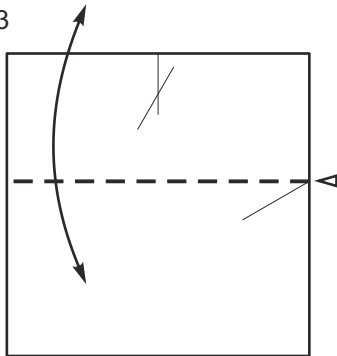

44

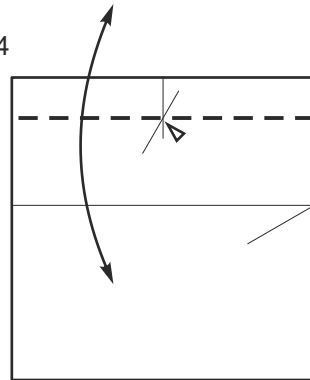

45

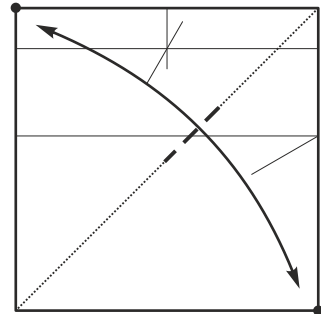

46

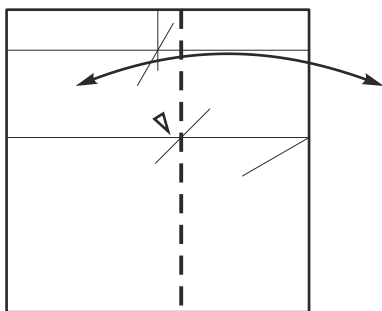

47

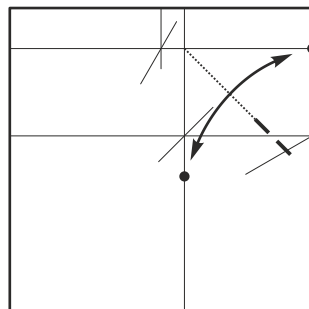

48

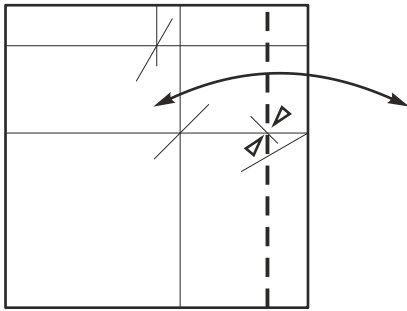

49

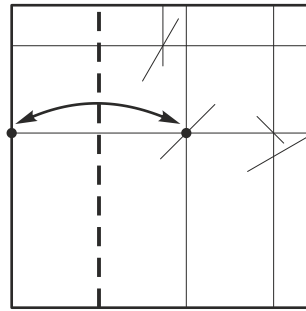

50

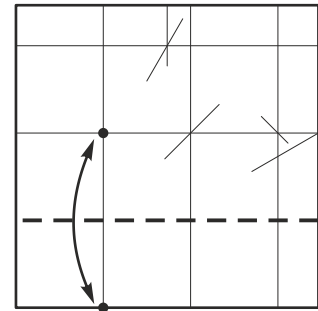

51

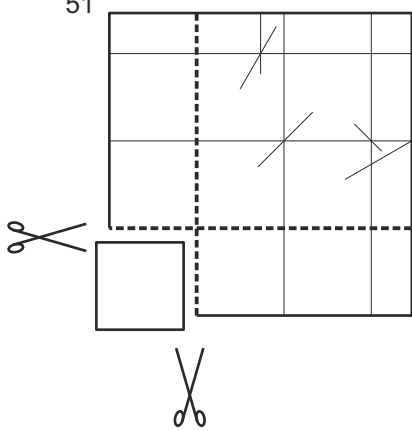

52

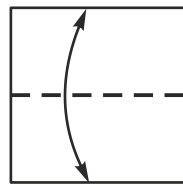

53

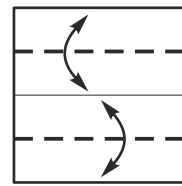

54

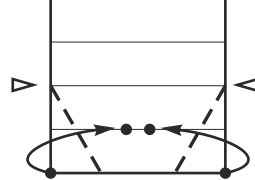

55

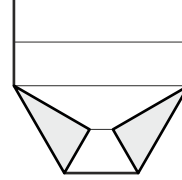

Unione di una tessera triangolare con una quadrata

56

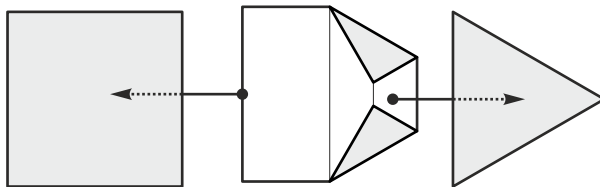

57

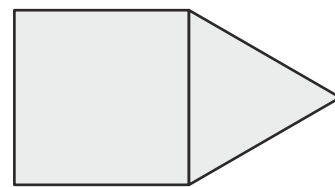

Unione di due tessere triangolari tra loro

58

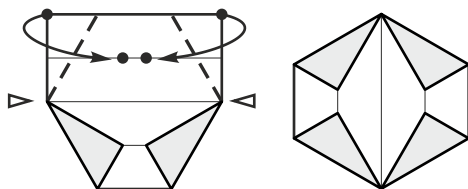

59

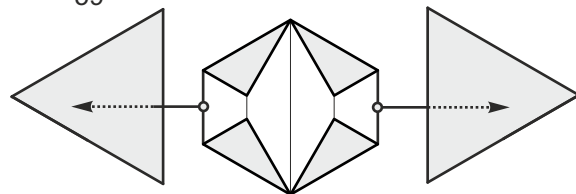

60

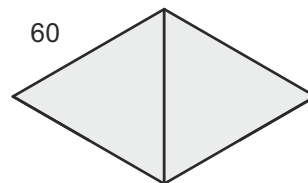

Due tessere triangolari unite con un giunto