

Cross Puzzle: un tangram alternativo
 Versione origami di F. Decio

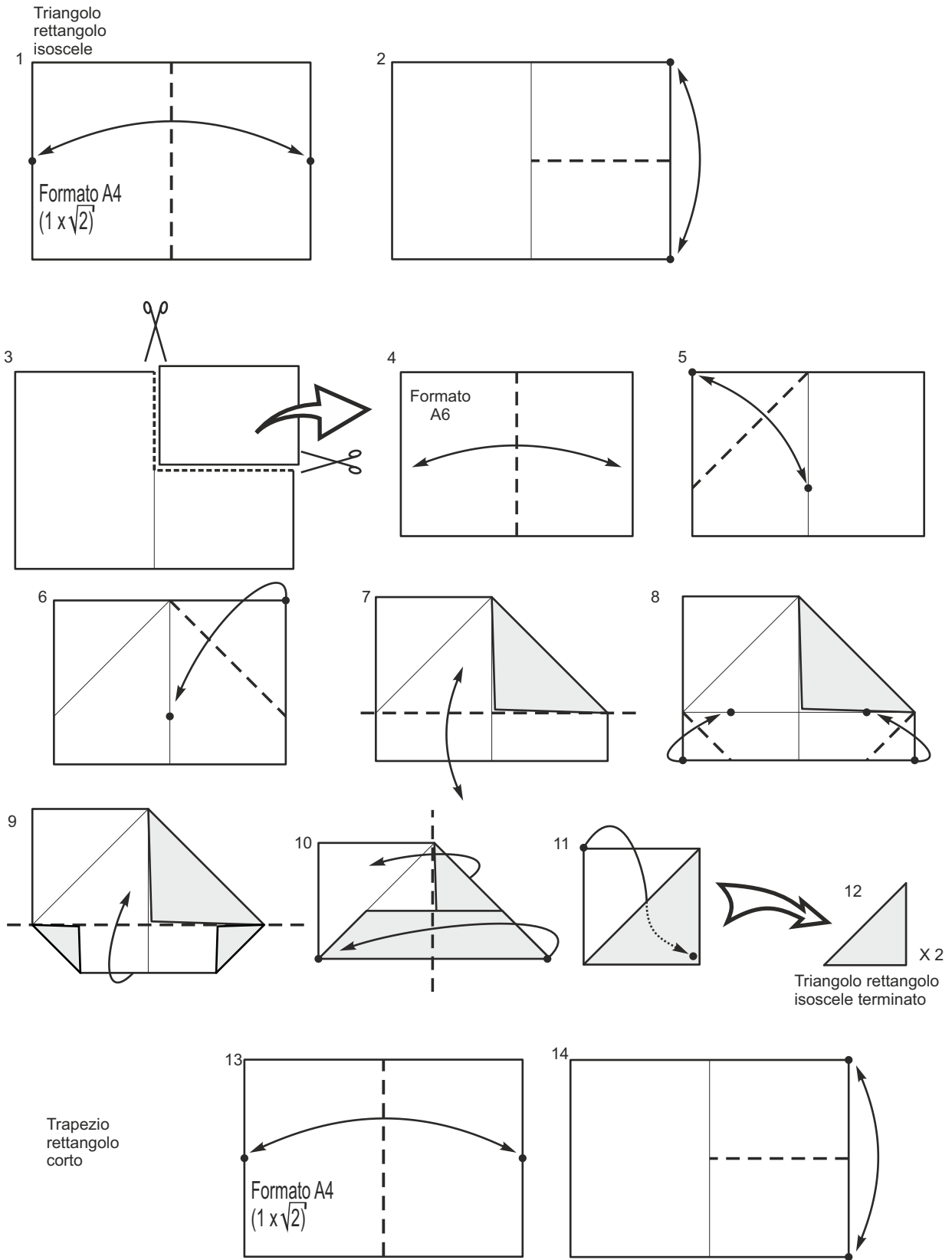

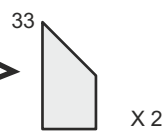
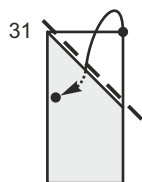
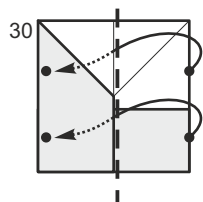
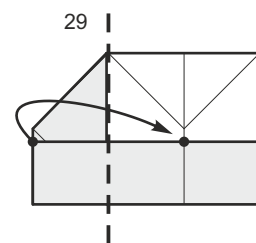
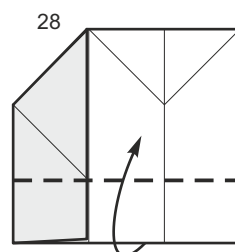
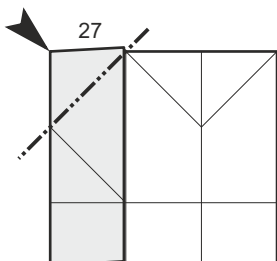
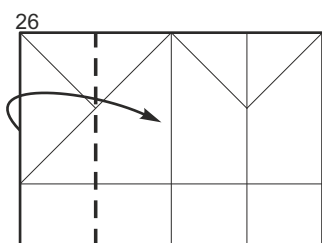
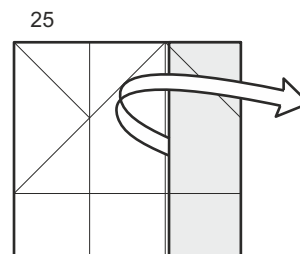
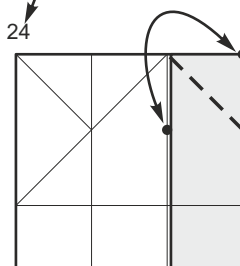
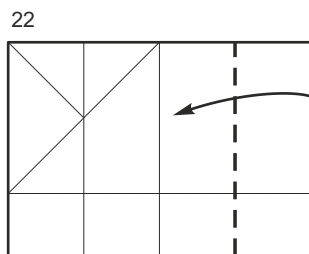
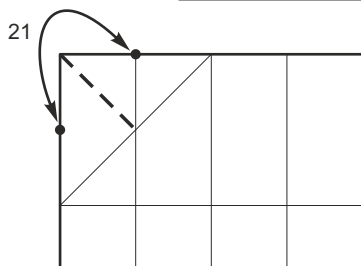
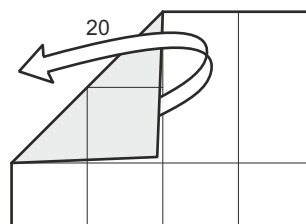
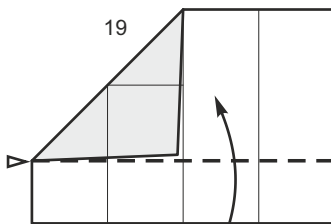
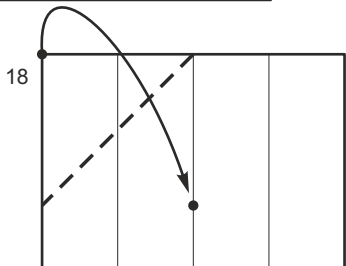
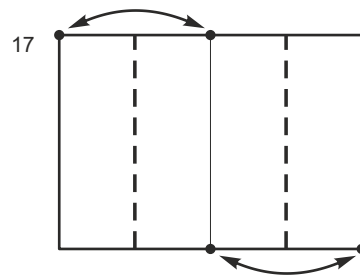
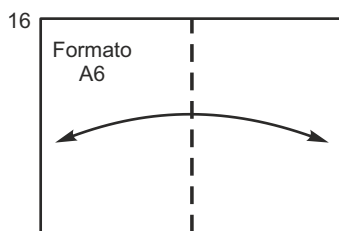
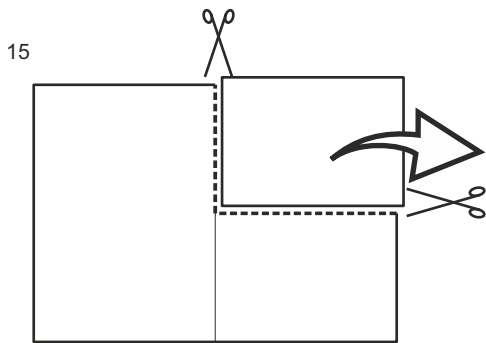

Trapezio rettangolo corto terminato

Trapezio rettangolo medio

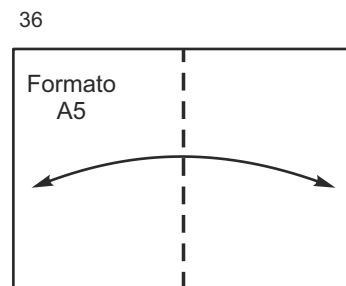
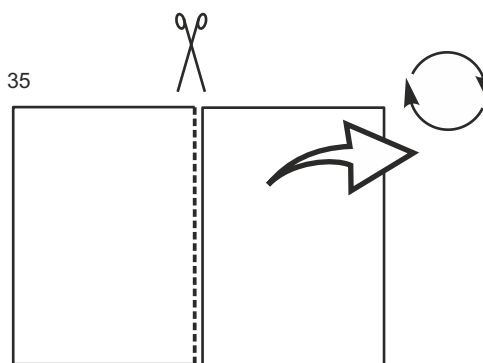
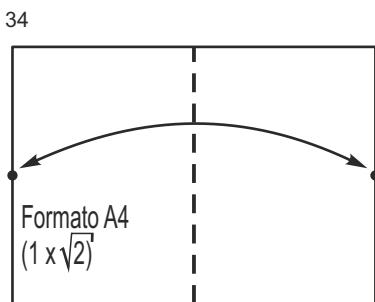

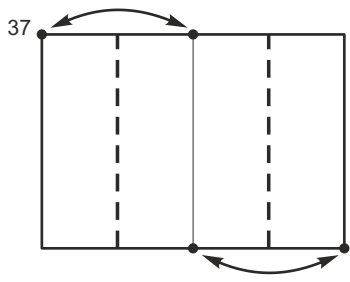

$$17 \div 33$$

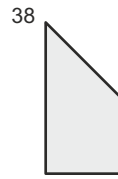

Trapezio rettangolo medio terminato

Trapezio rettangolo LUNGO

39

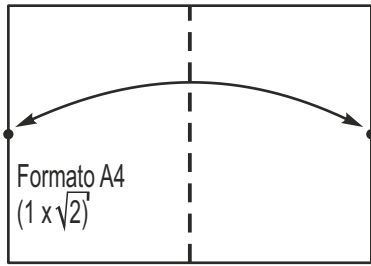

40

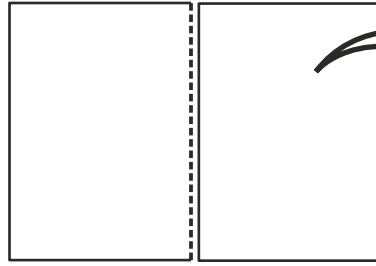

41

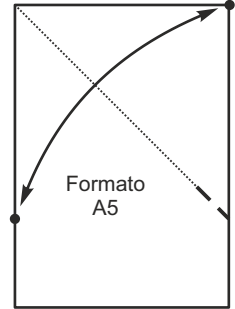

42

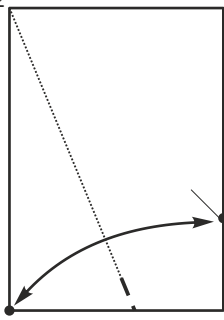

43

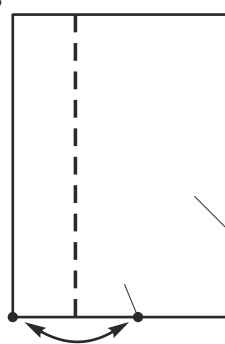

44

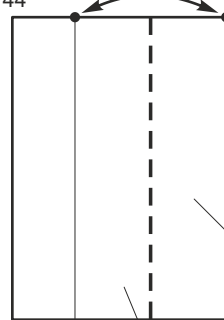

45

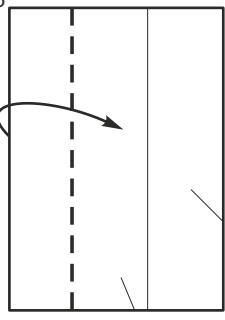

46

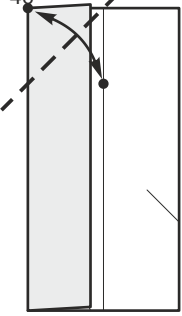

47

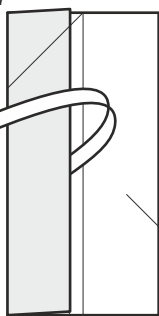

48

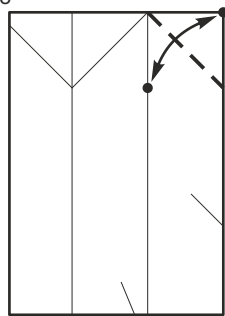

49

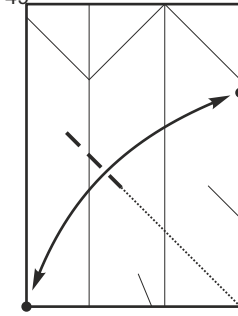

50

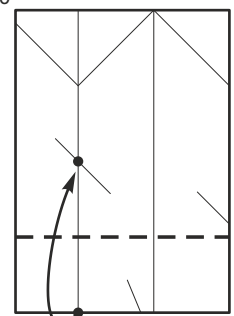

51

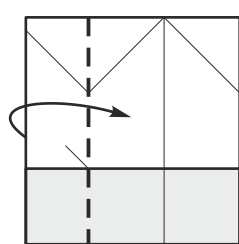

52

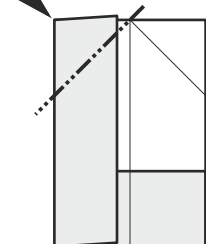

53

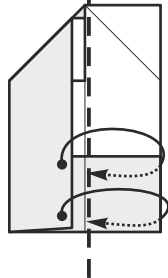

54

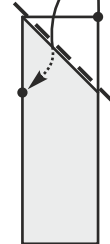

55



Trapezio rettangolo LUNGO terminato

Pentagono irregolare

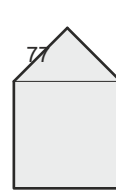
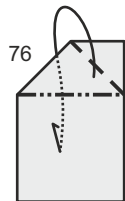
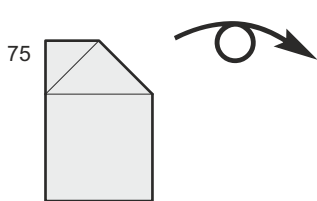
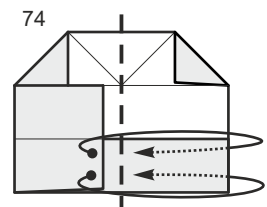
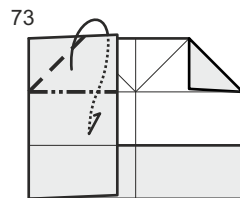
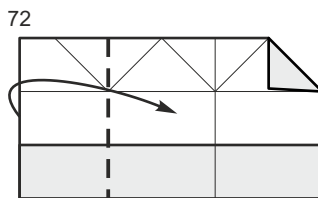
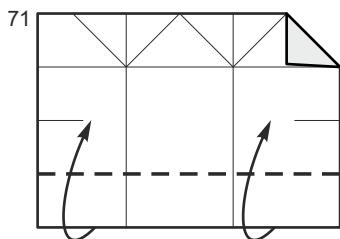
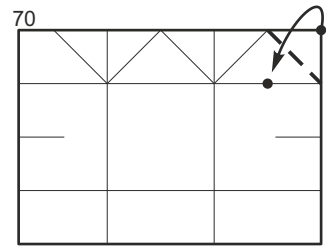
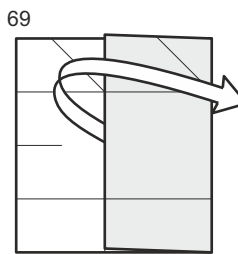
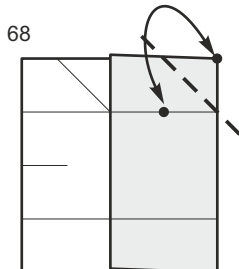
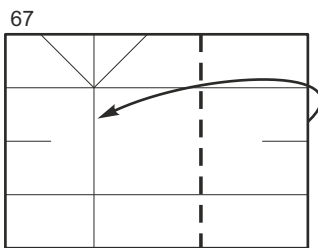
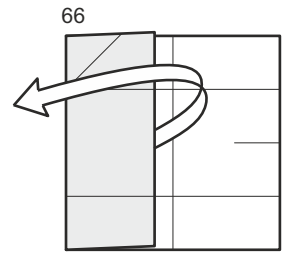
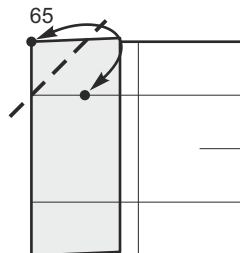
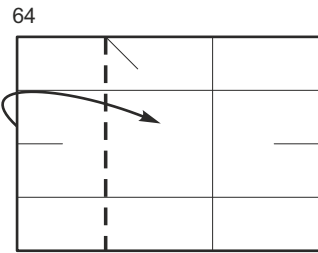
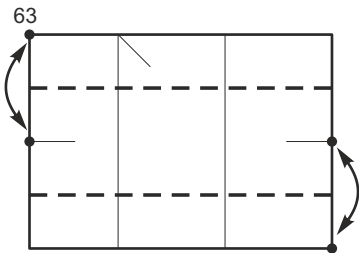
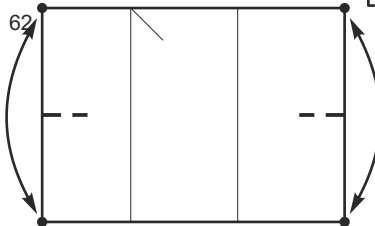
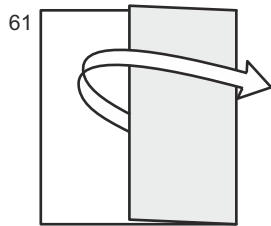
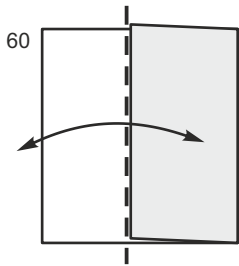
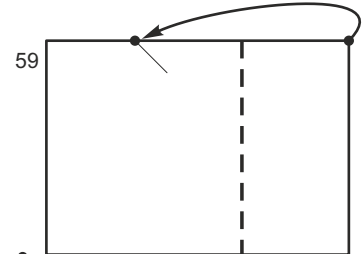
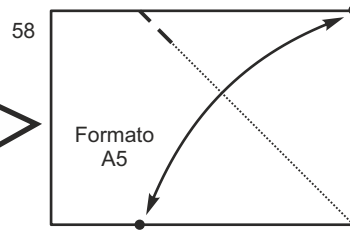
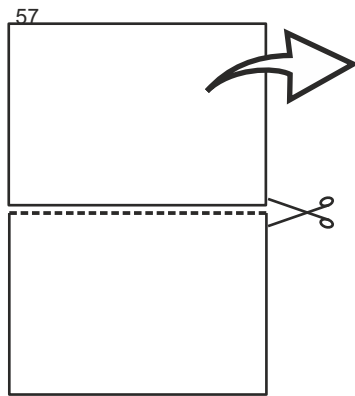
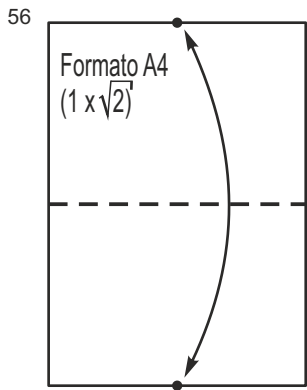

Pentagono
terminato

Alcune figure possibili con i 7 pezzi

Nota bene: alcune figure ammettono la composizione in due o anche più modi diversi al netto di soluzioni a specchio.

Gli eventuali «doppioni» che si possono incontrare rendono conto di queste diverse soluzioni.

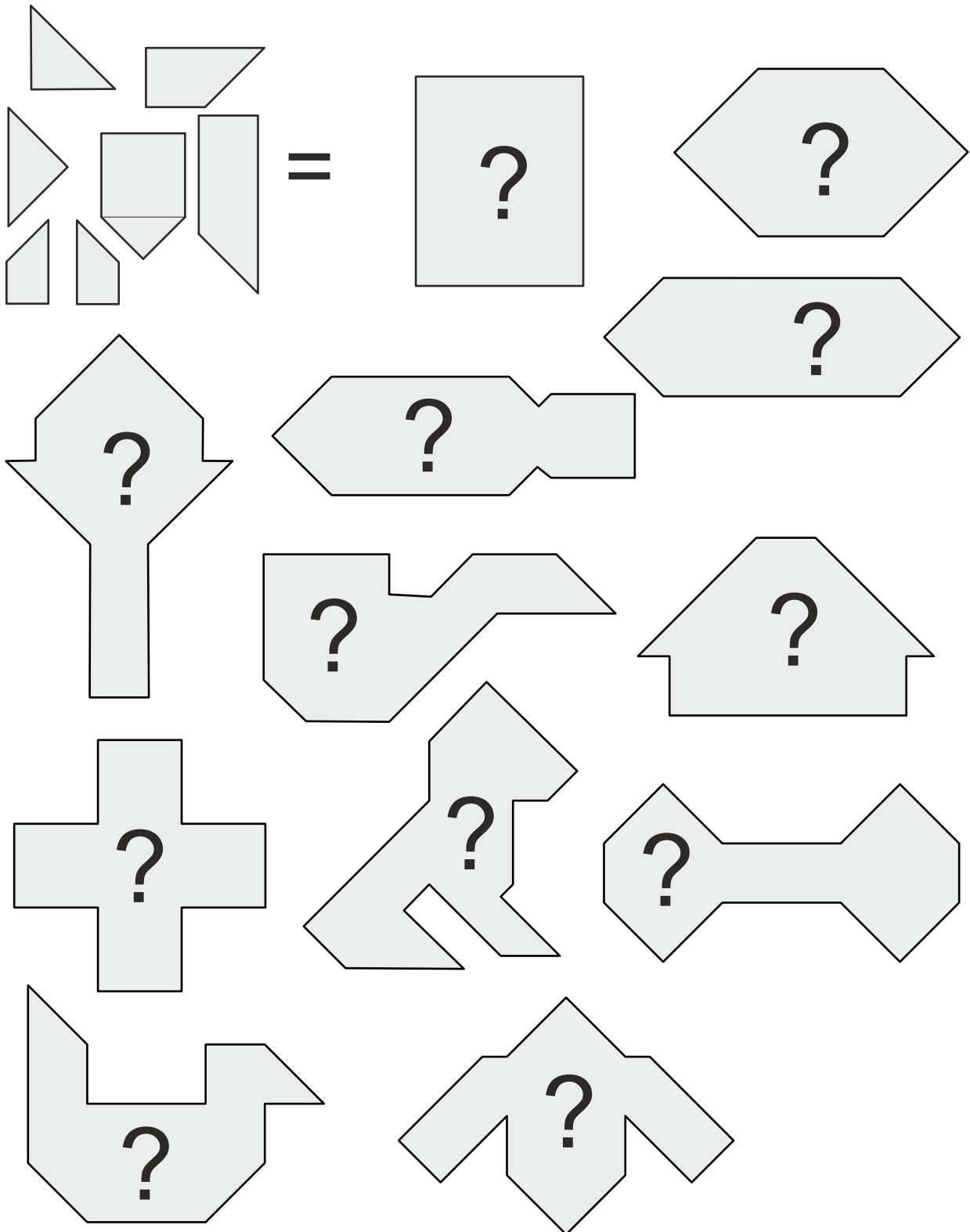

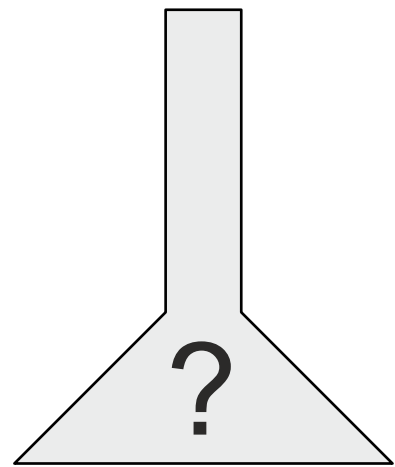
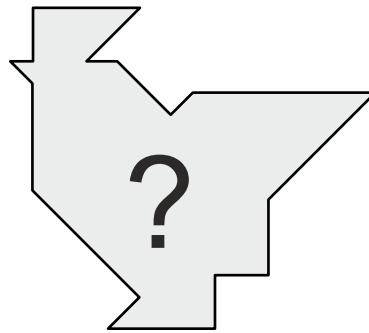
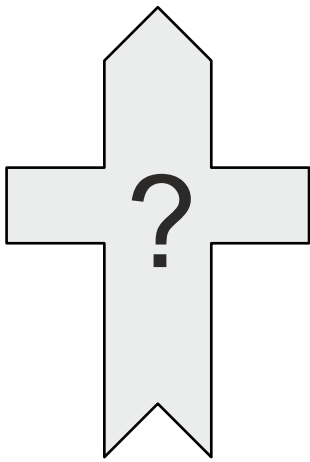
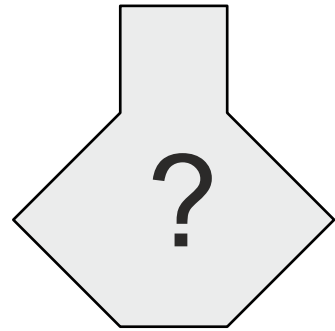
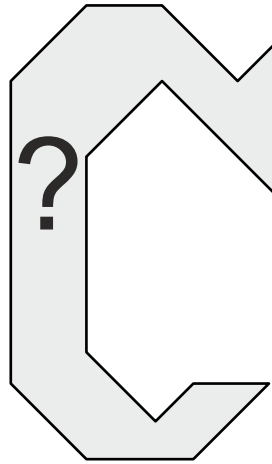
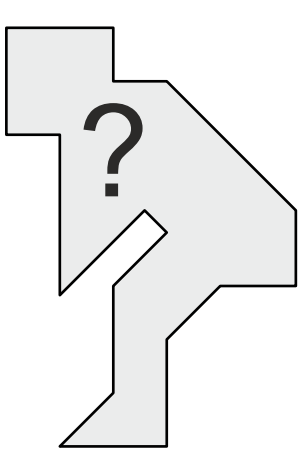

Figure proposte da Gisella Maculan

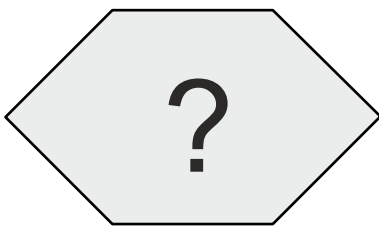
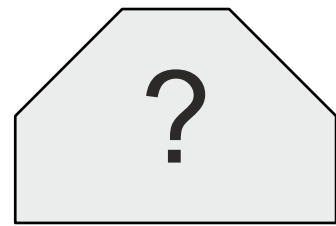
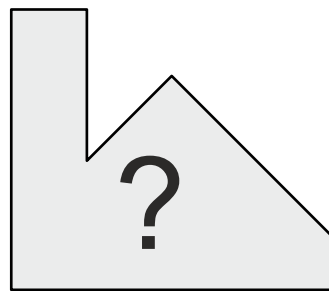
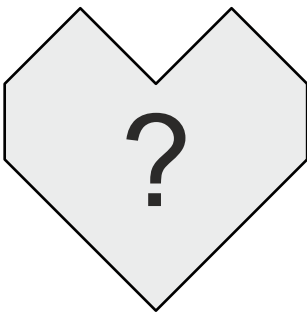
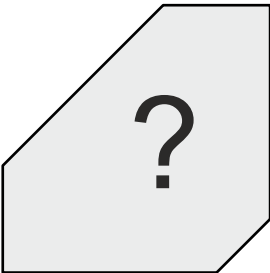
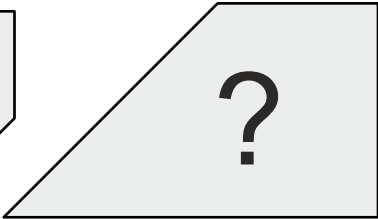
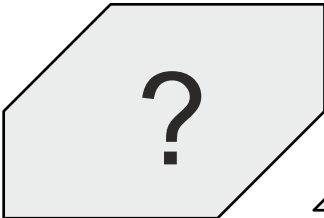
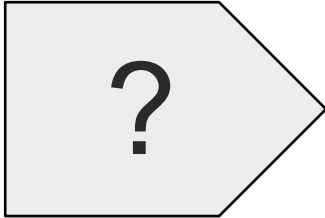
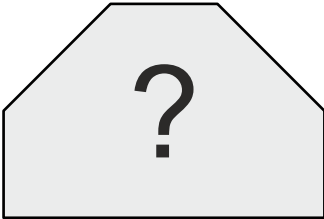
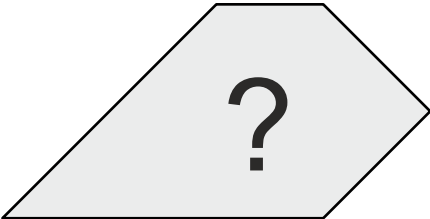
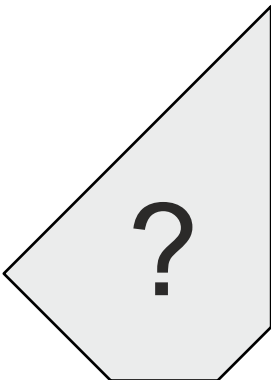
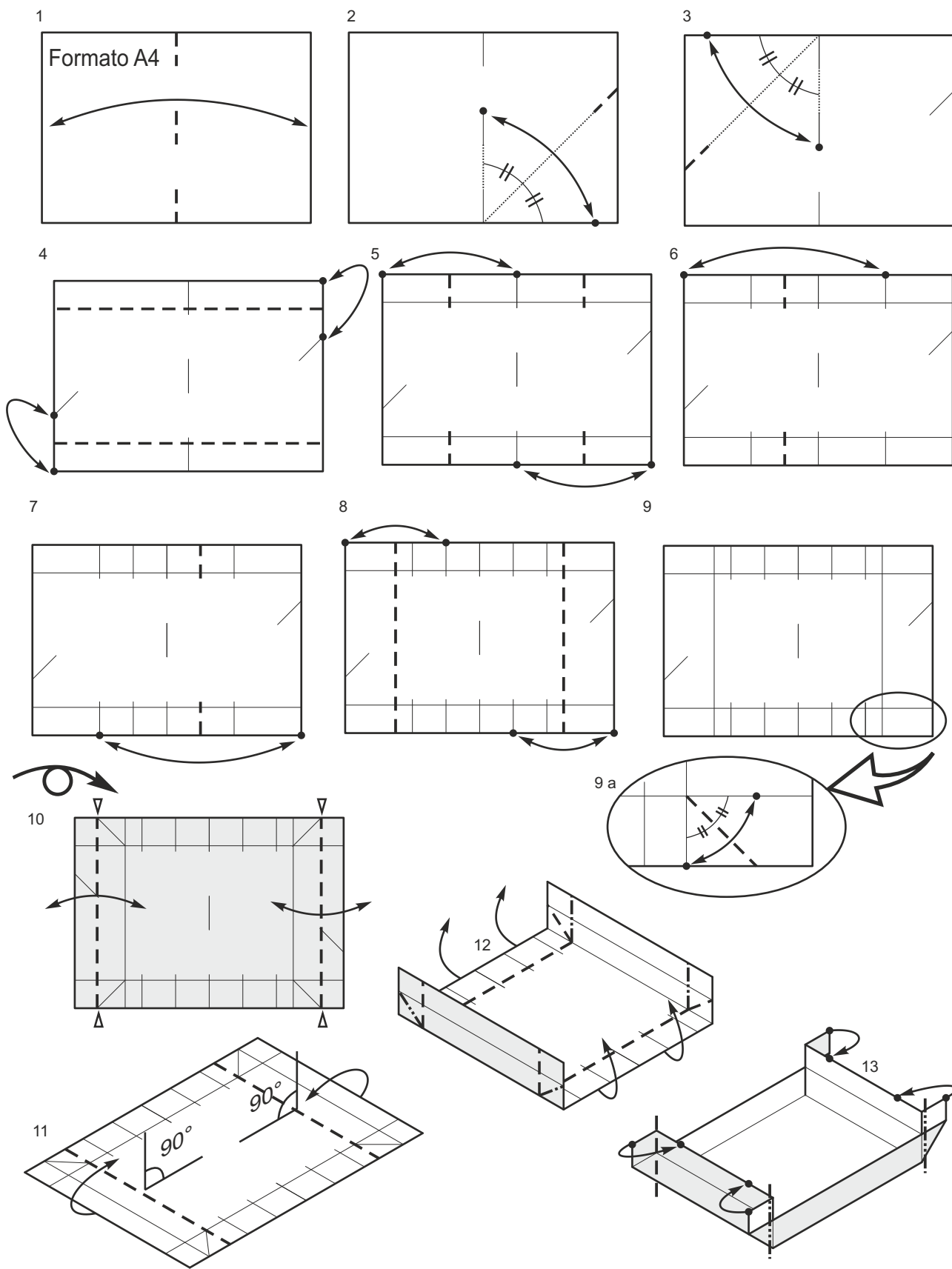
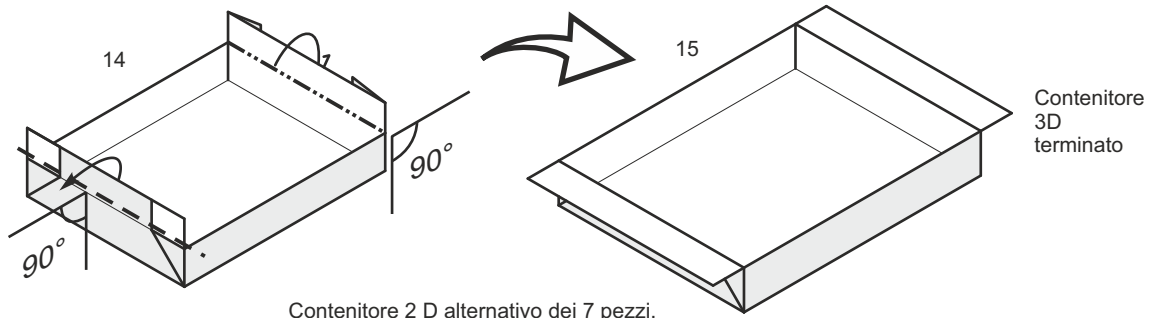

Figure proposte da Luciana Piras



Contenitore 3D dei vari pezzi





Contenitore
3D
terminato

Contenitore 2 D alternativo dei 7 pezzi.
Di Francesco Decio
Disegni di F. Decio

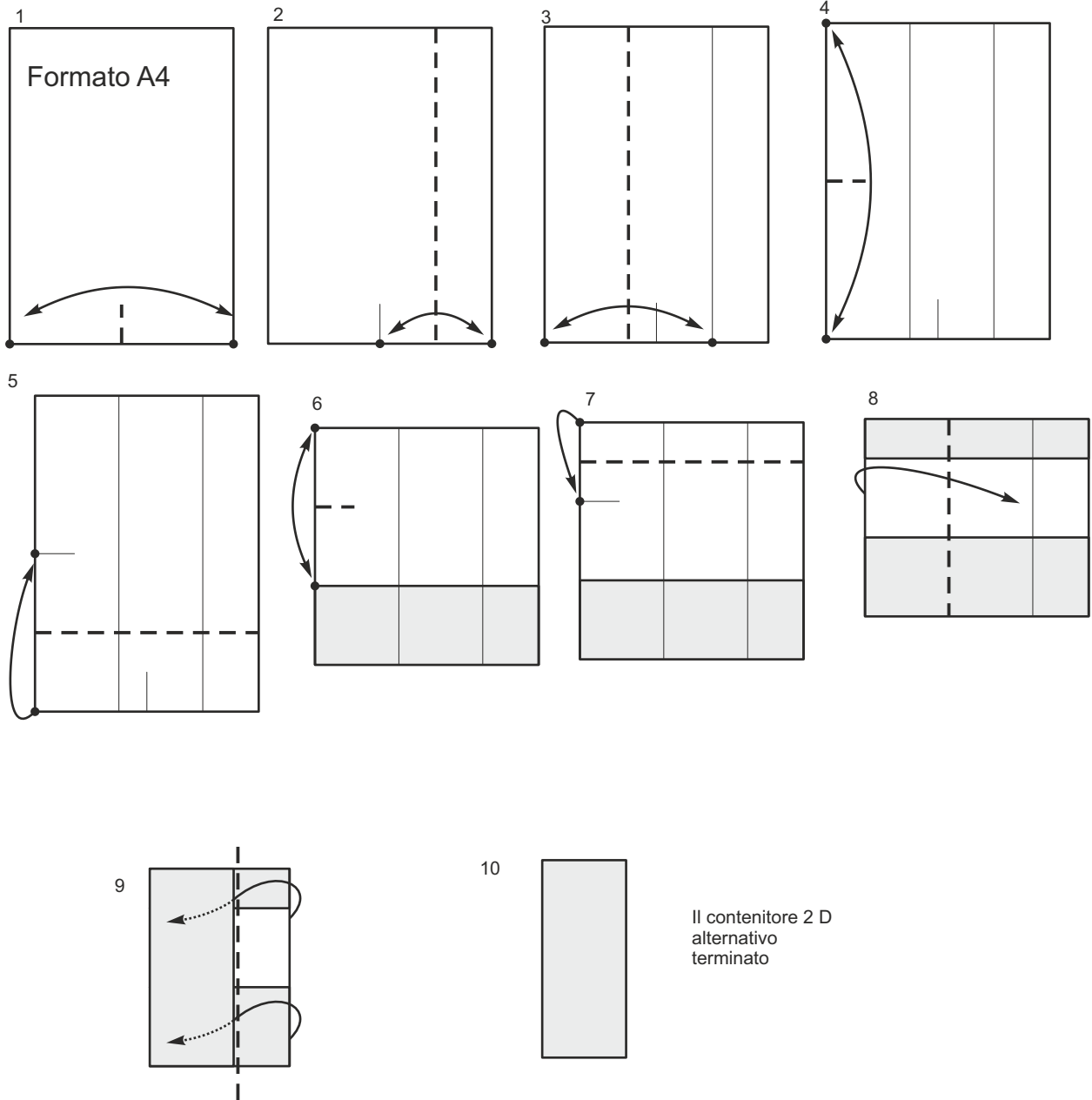

Il contenitore 2 D
alternativo
terminato

