

Deltoide CONCAVO

1

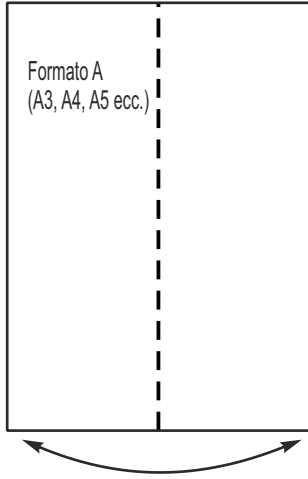

2

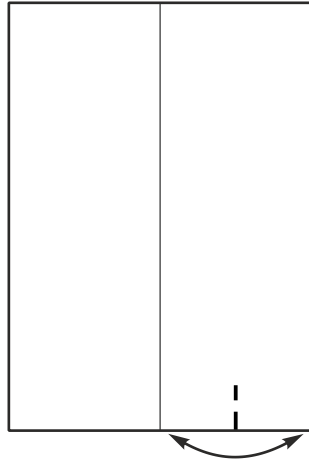

3

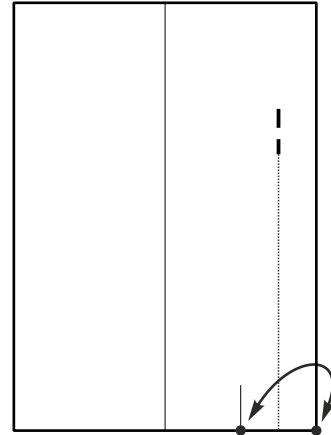

4

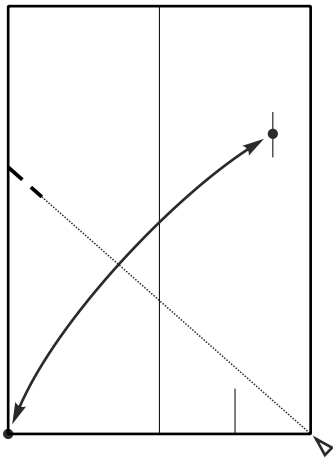

5

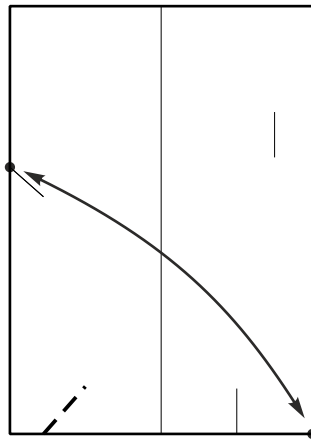

6

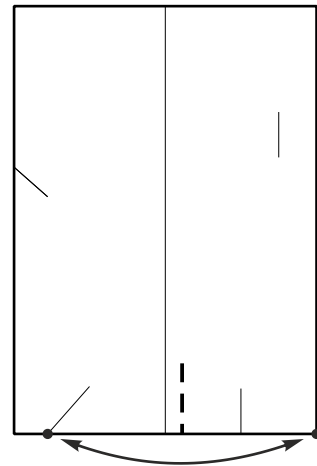

7

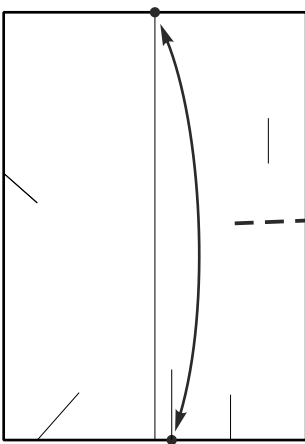

8

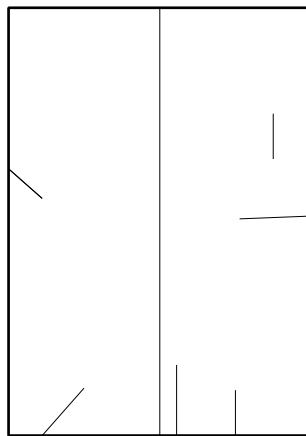

9

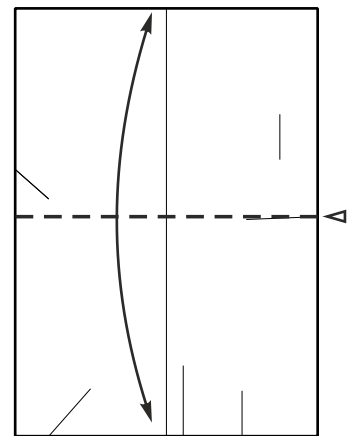

10

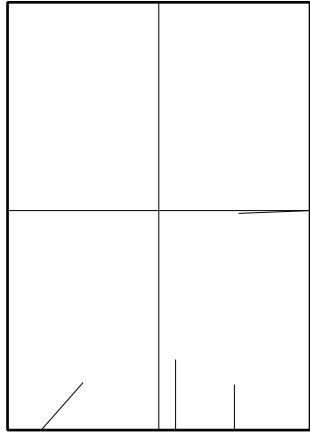

11

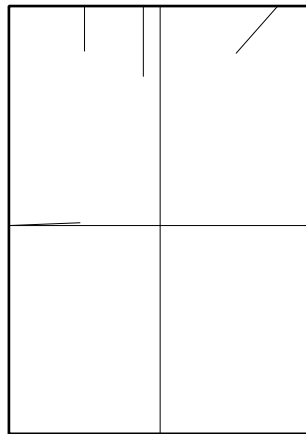

12

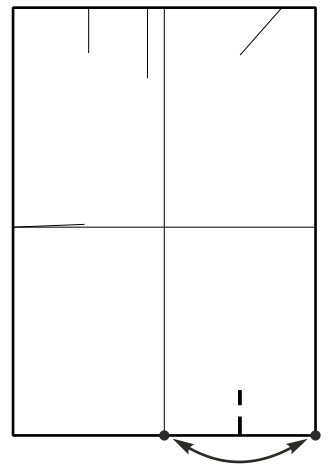

13

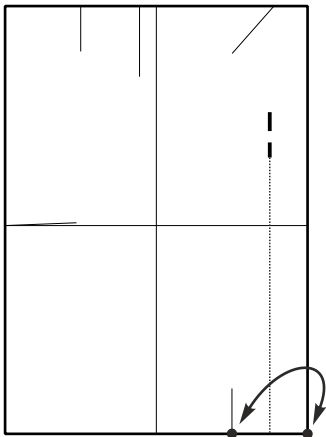

14

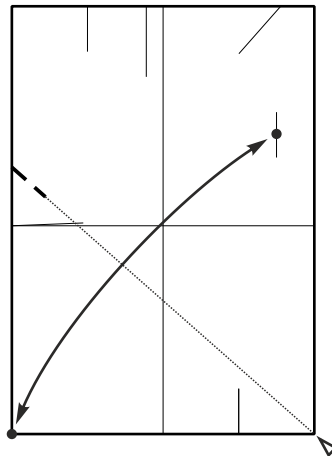

15

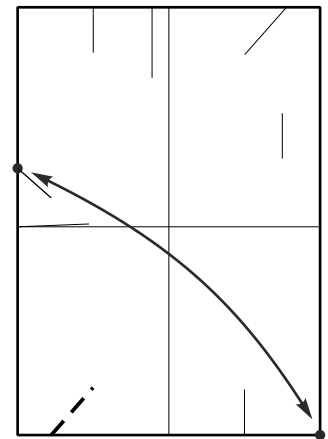

16

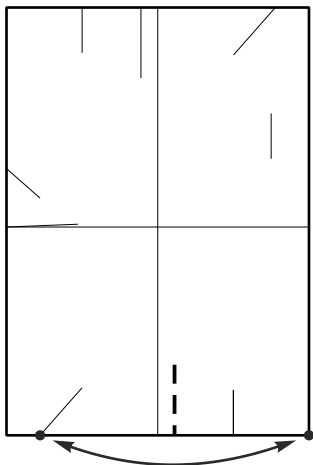

17

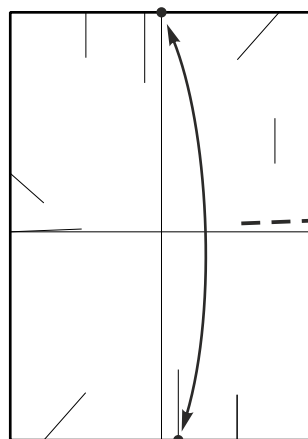

18

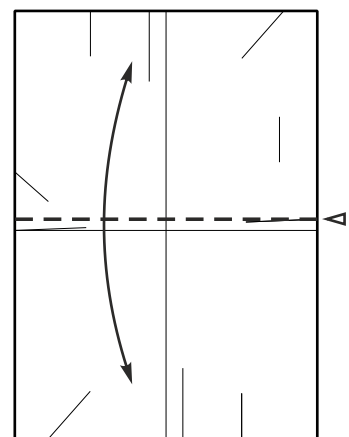

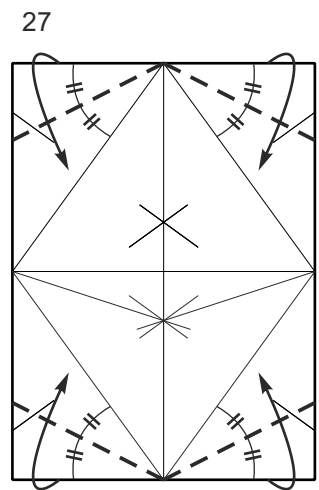
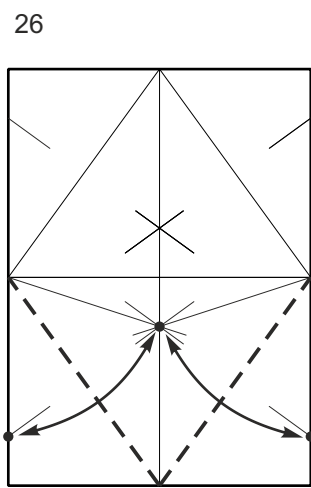
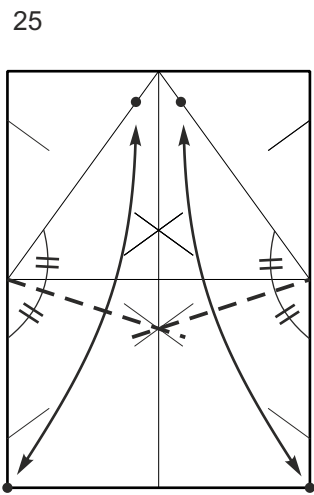
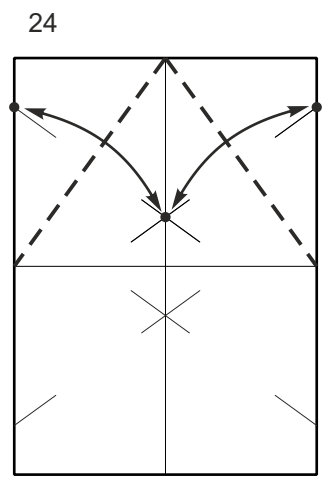
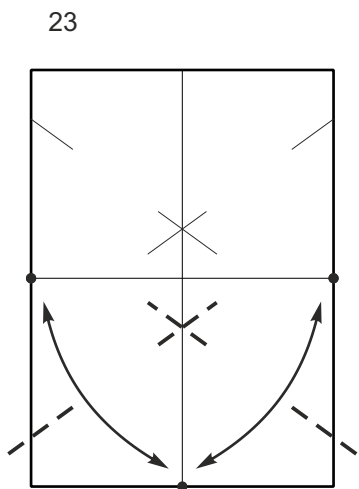
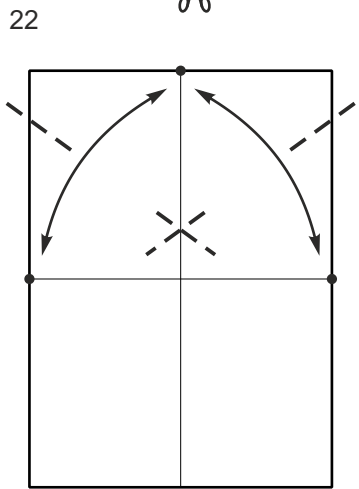
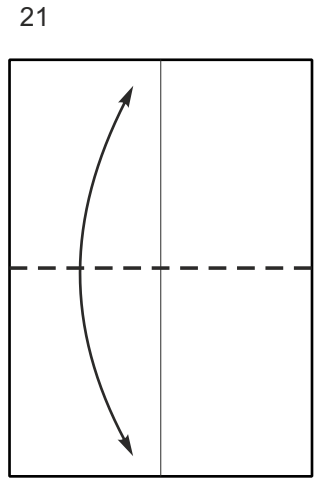
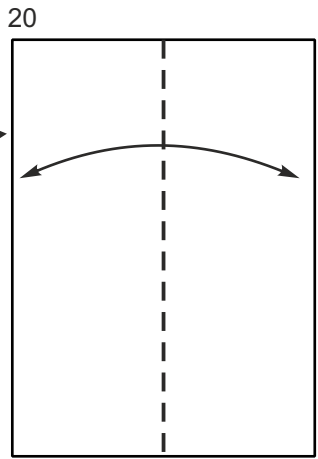
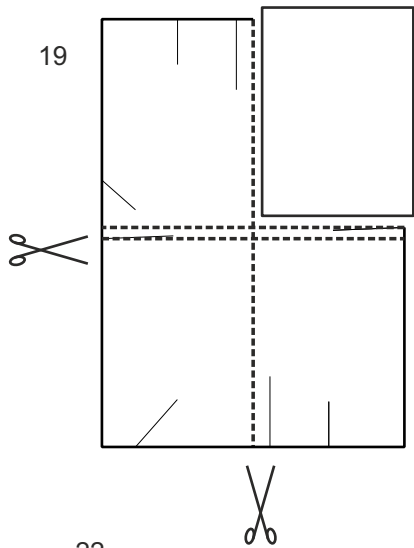

28

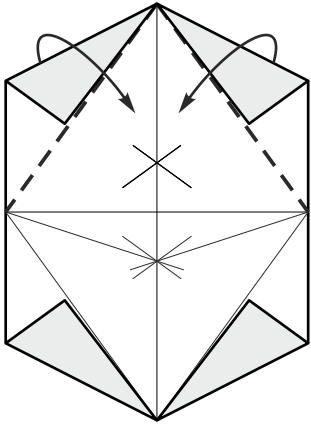

29

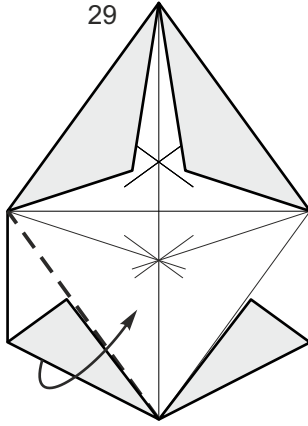

30

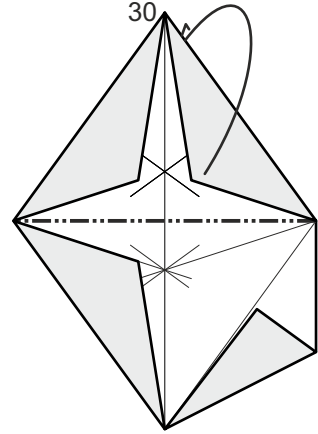

31

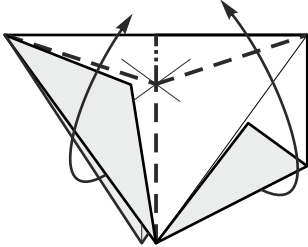

32

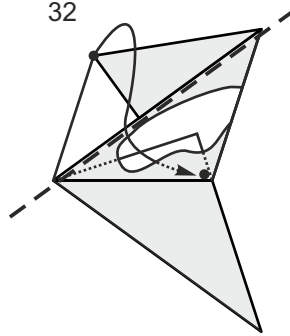

33

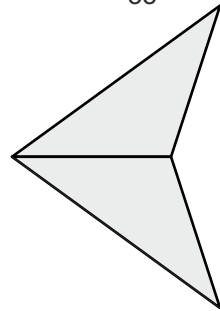

Deltoide
concavo
di Penrose
terminato

Deltoide convesso

Partire dal n. 19

34

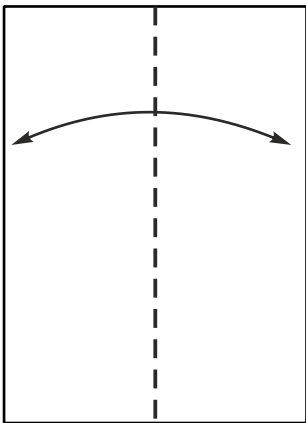

35

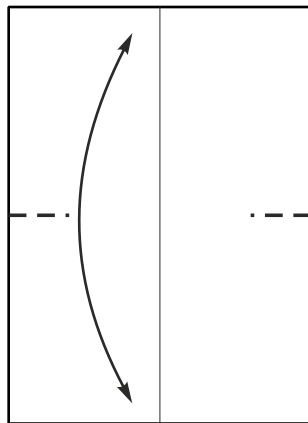

36

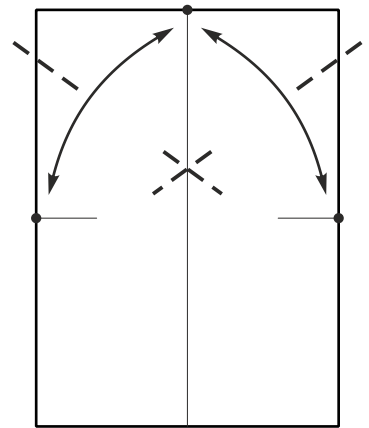

37

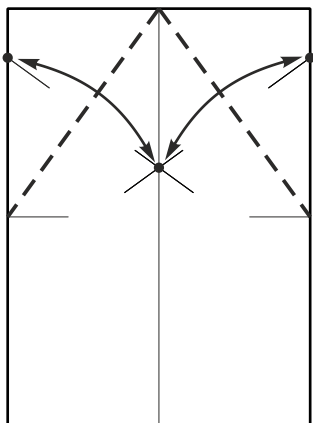

38

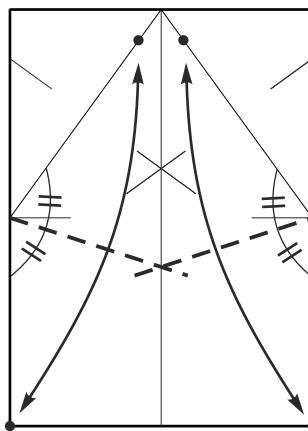

39

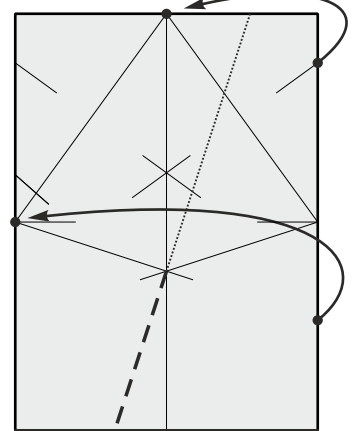

40

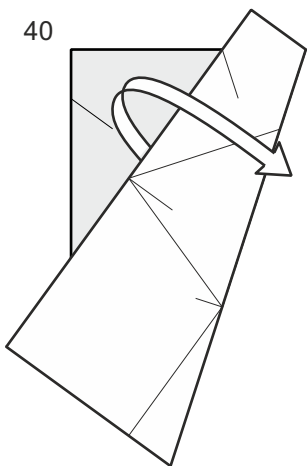

41

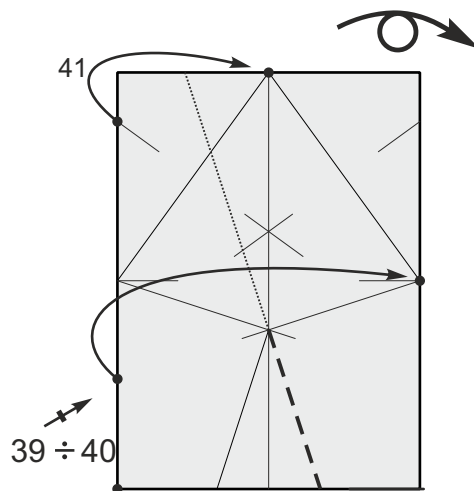

42

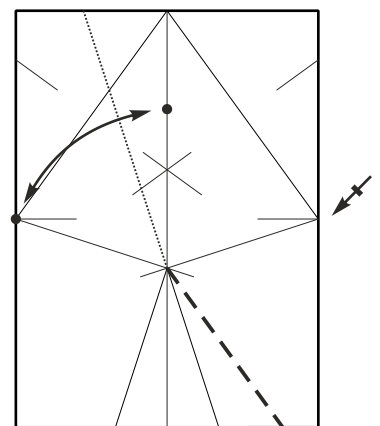

43

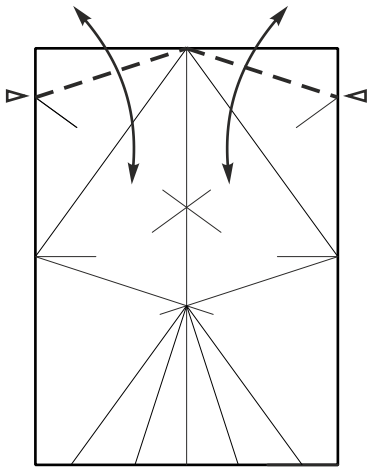

44

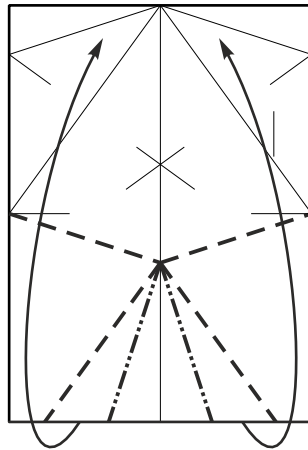

45

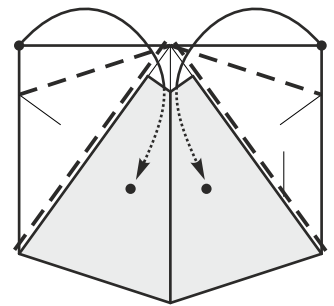

46

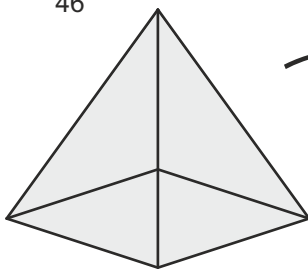

47

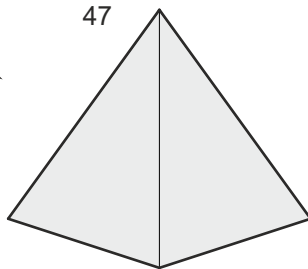

Deltoide
convesso
di Penrose
terminato