

Forme diverse / volumi equivalenti

Preparazione fogli $1 \times \sqrt{3}$ per 6 tessere triangolari equilatero e 7 giunti. Modulo di Gigi Verri

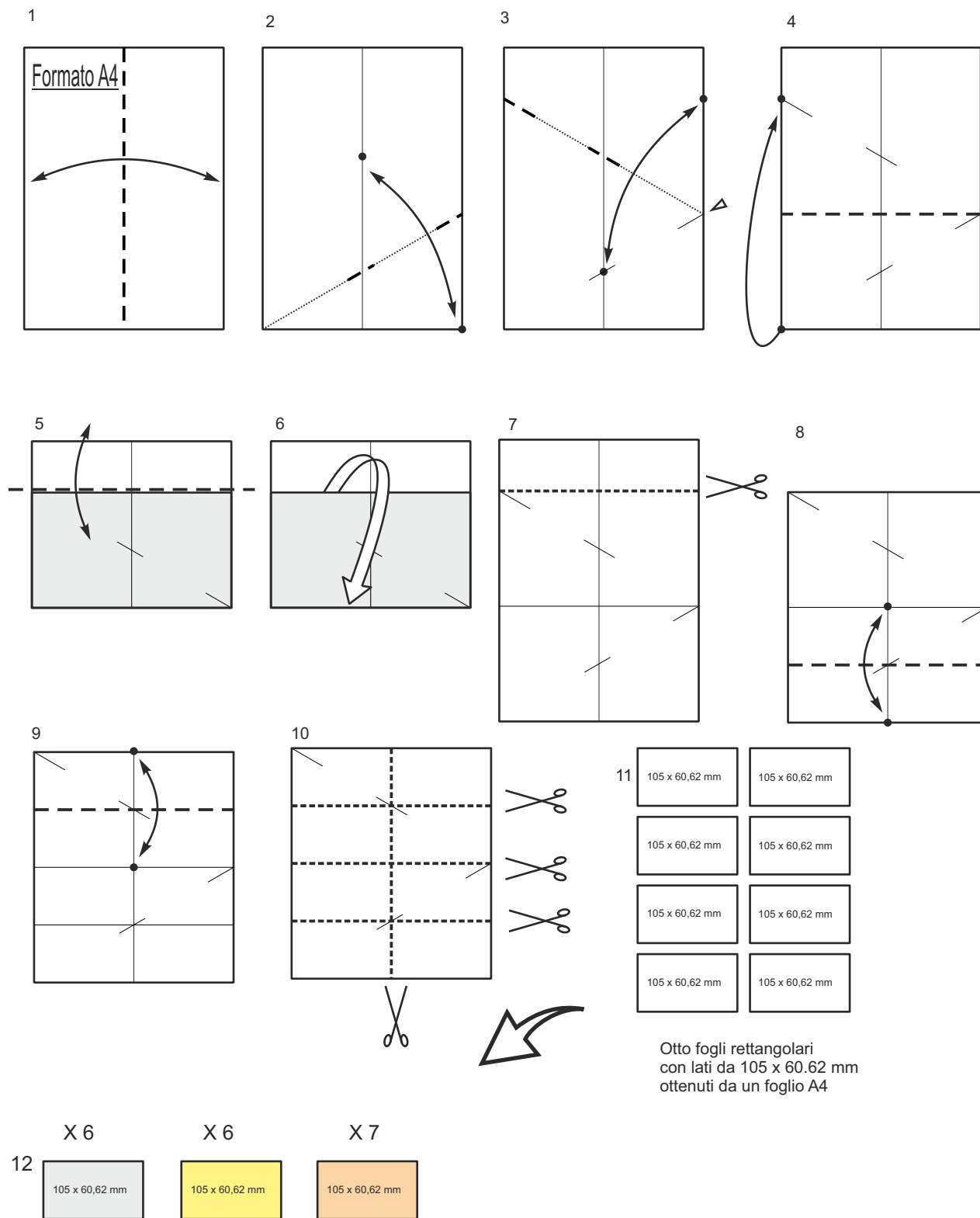

Preparazione di 6 tessere triangolari.

Modulo n. 1

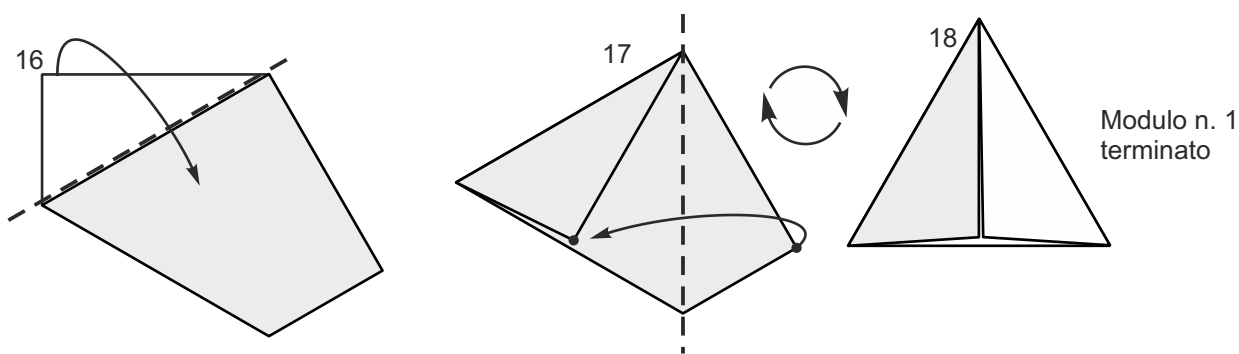
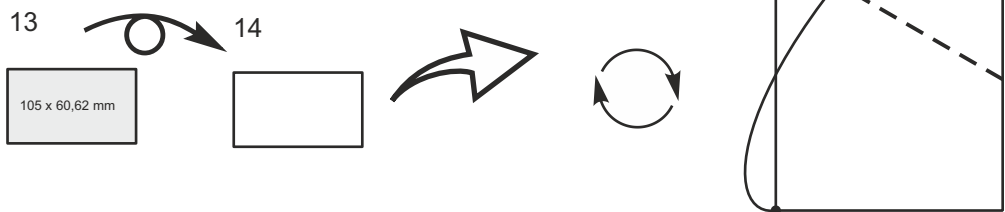

Modulo n. 2

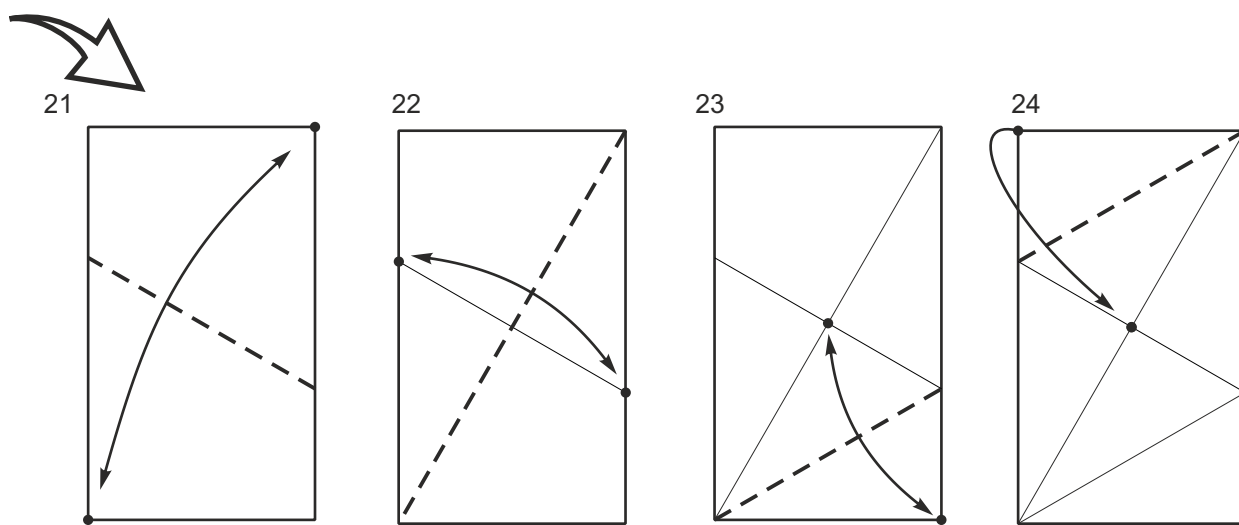
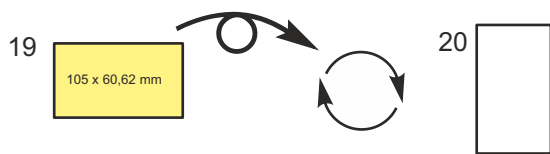

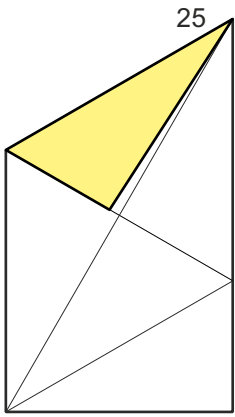

Modulo n. 2
terminato

Unione dei due moduli

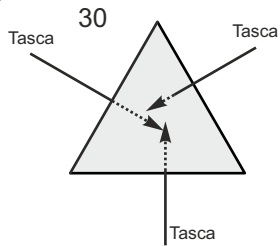
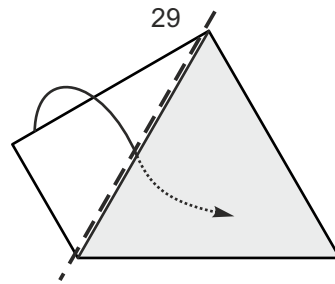
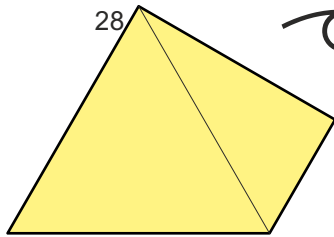
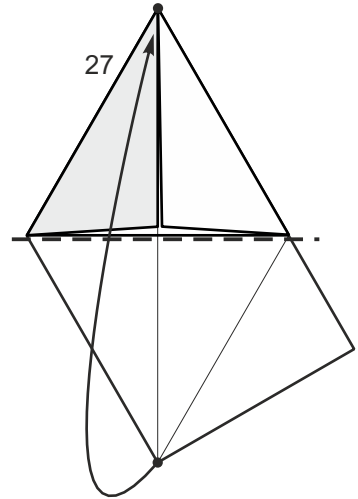
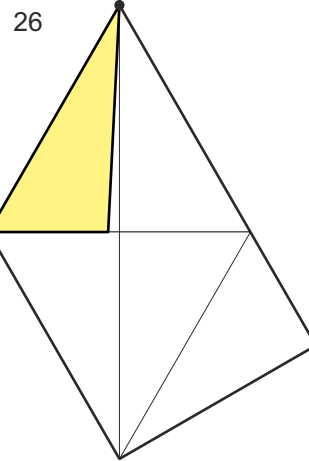
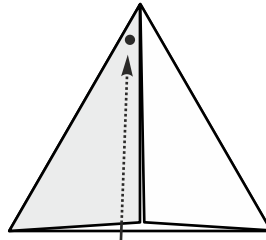

Unione
terminata.
Tessera a tre
tasche pronta.

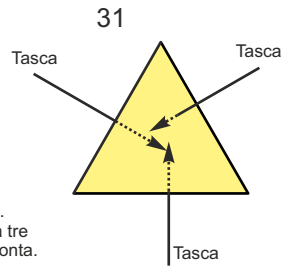

X 6

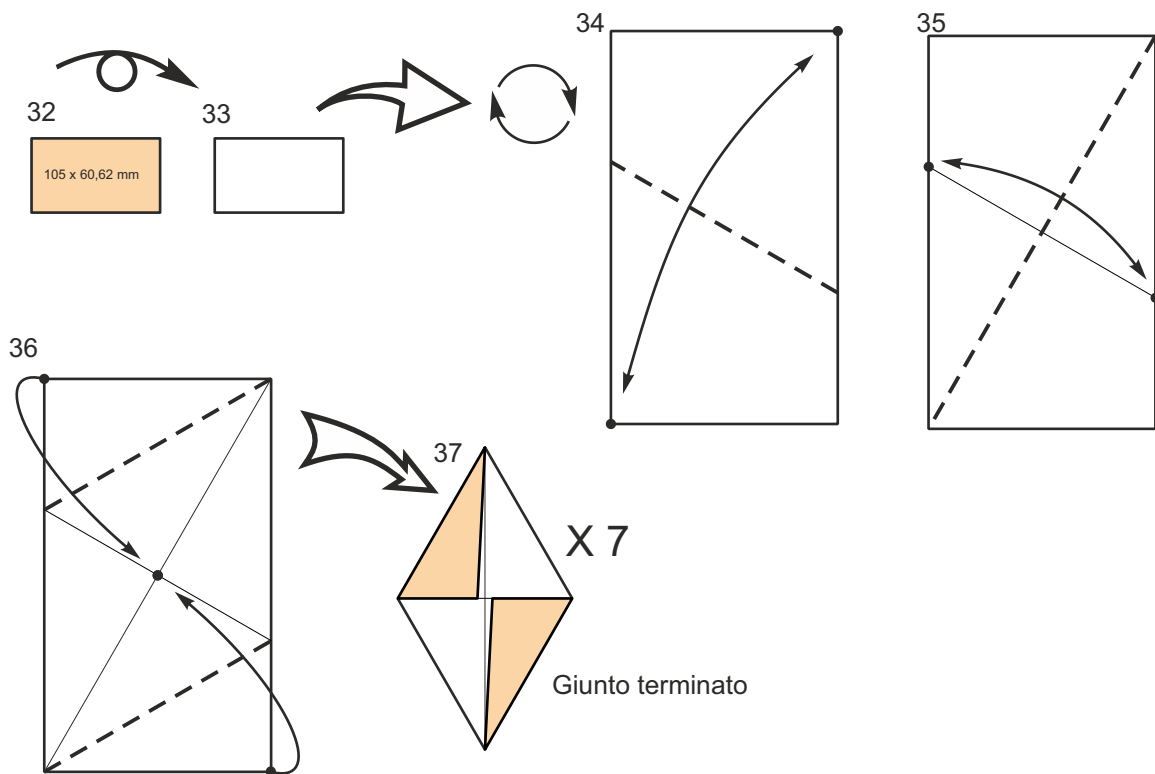

Unione delle tessere con i giunti per ottenere il tetraedro regolare

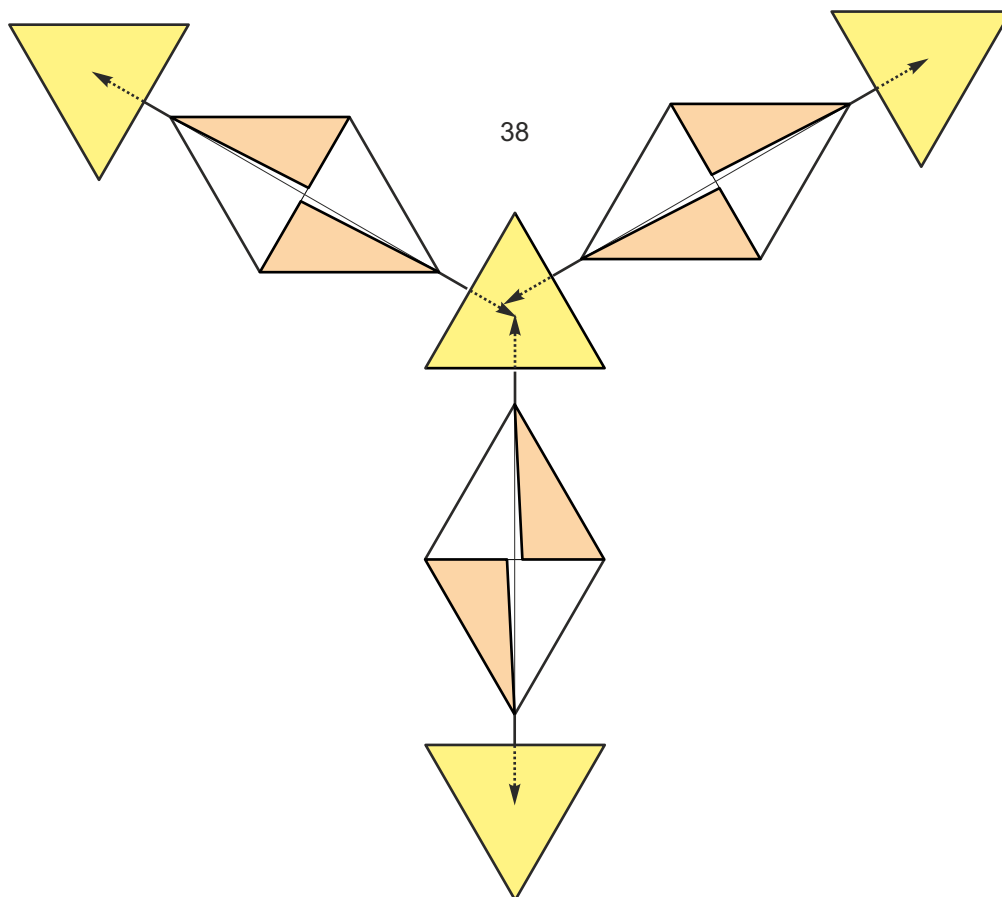

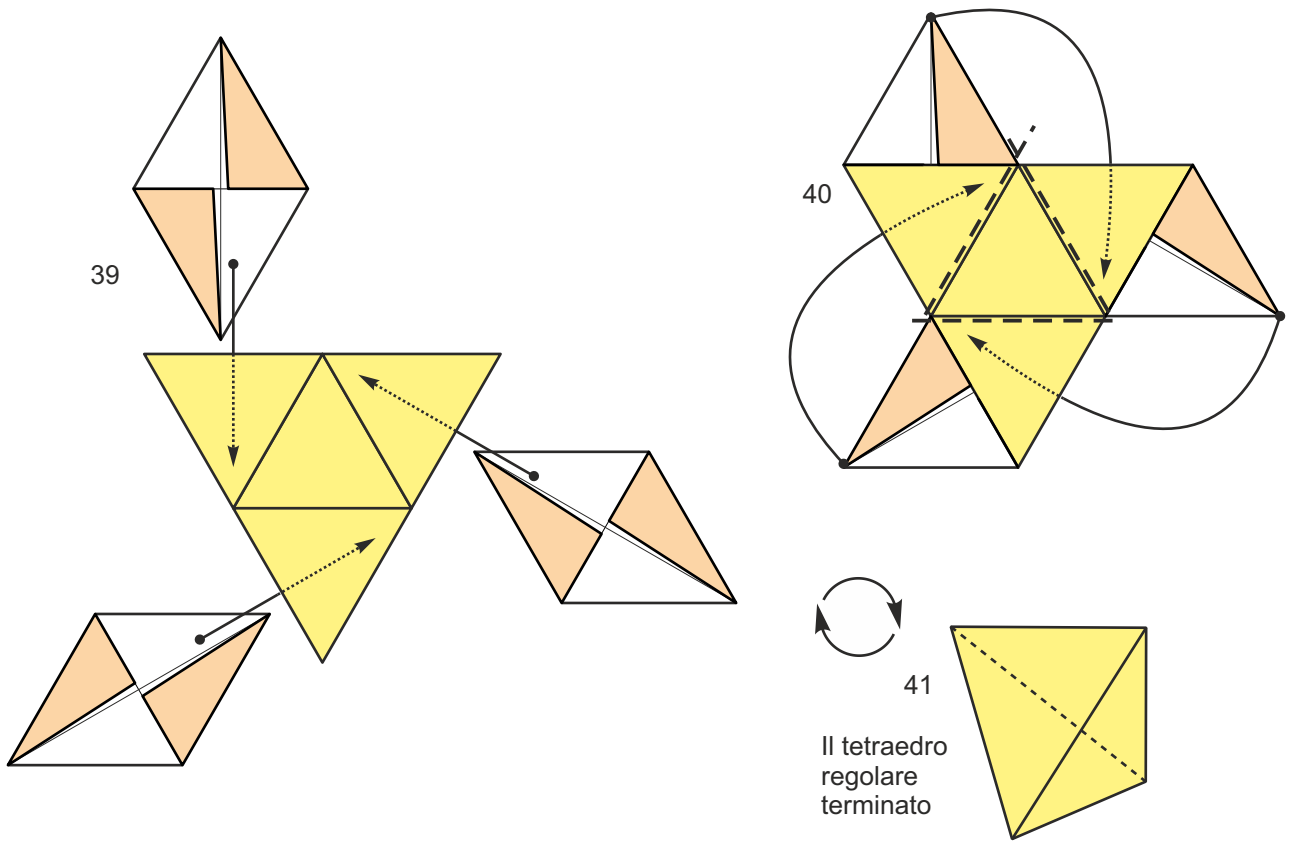

Assemblaggio tetraedro IRREGOLARE

Unione di due tessere triangolari con un giunto

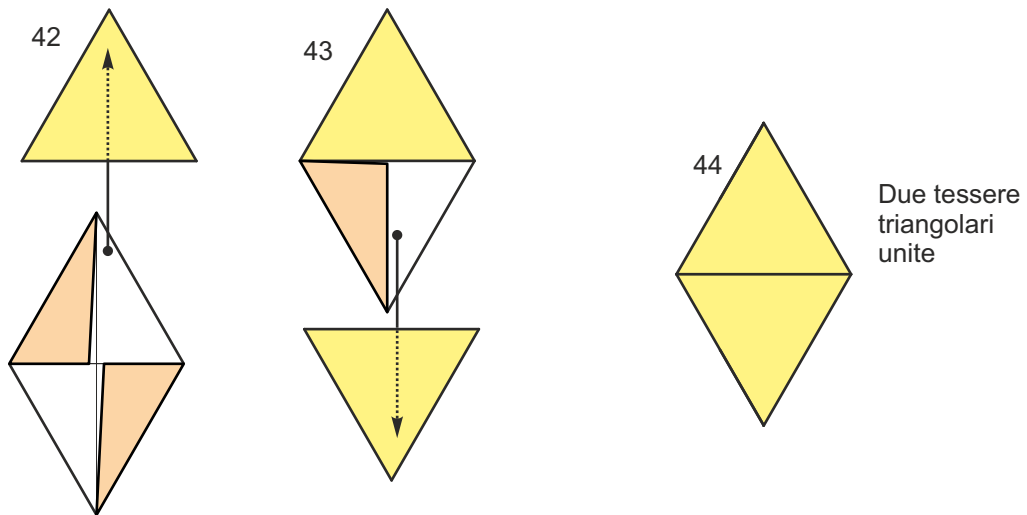

Procedura per tessere QUADRATE da foglio A4
COMPATIBILI con le tessere triangolari precedenti

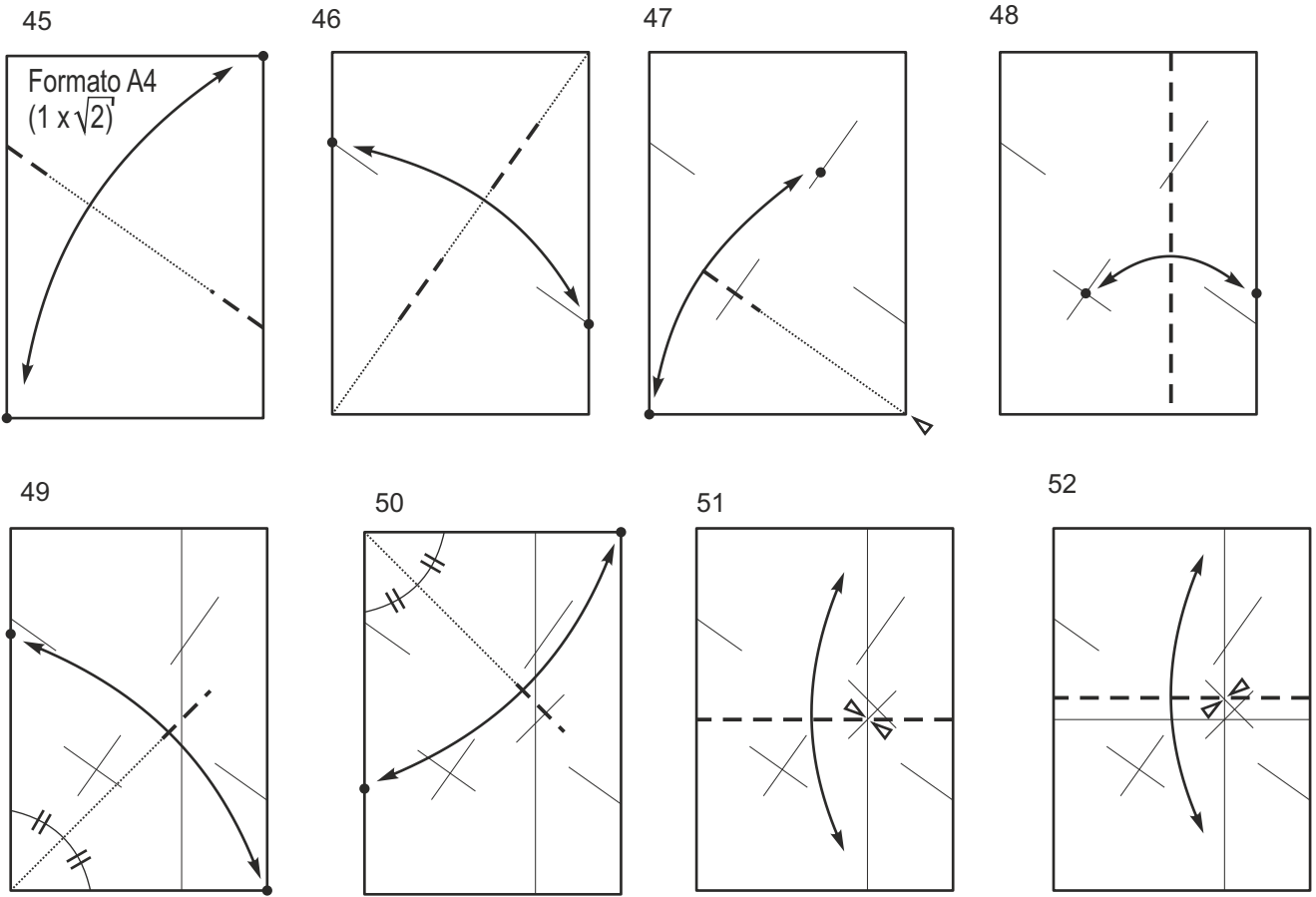

La procedura indicata consente di ottenere due quadrati con lato 14 cm.

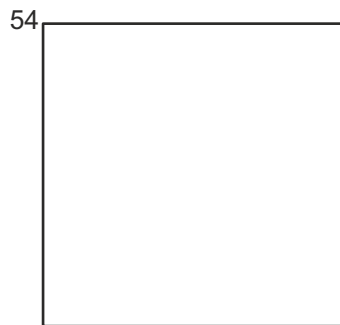
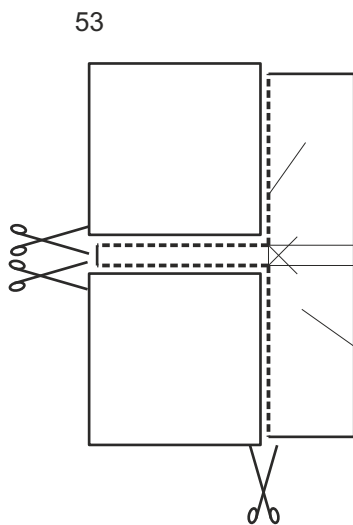

Da questo quadrato proseguire per ottenere la tessera quadrata

Tessera quadrata a 4 tasche

55

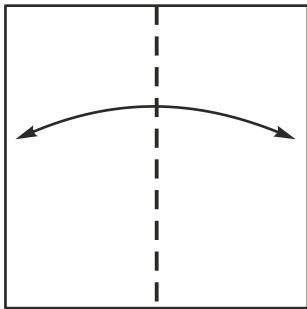

Secondo pezzo

56

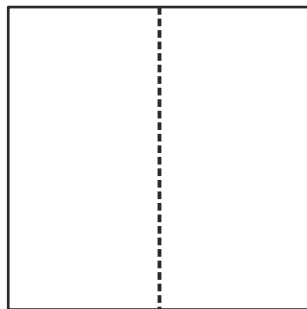

57

Piegare il lato inferiore con lunghezza a piacere

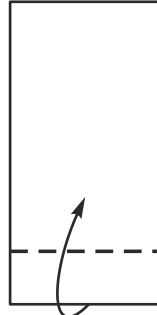

Piegare il lato superiore portando a combaciare i punti indicati

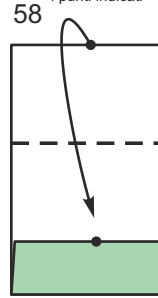

Primo pezzo della tessera terminato

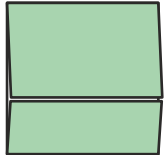

Piegare il lato inferiore con lunghezza a piacere

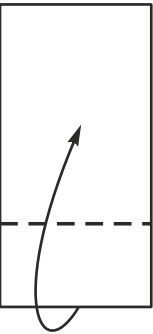

61

Piegare il lato superiore portando a combaciare i punti indicati

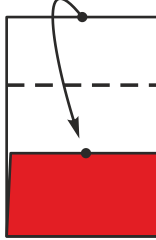

62

Riaprire tutto il foglio



63

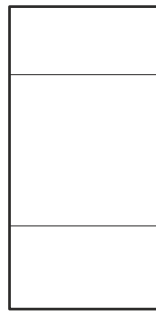

Ruotare il foglio di 90 gradi



64

Secondo pezzo della tessera terminato

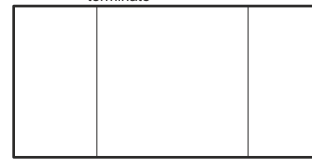

Unione dei due pezzi

65

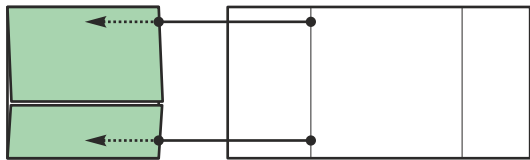

66

Inserire l'estremità destra del secondo pezzo nella tasca del primo

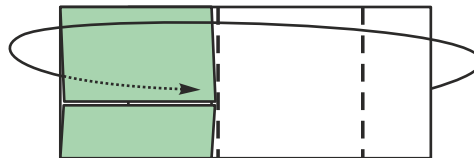

67



68



69

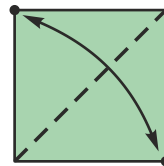

70

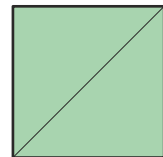

La tessera quadrata terminata

Giunto per tessere quadrate

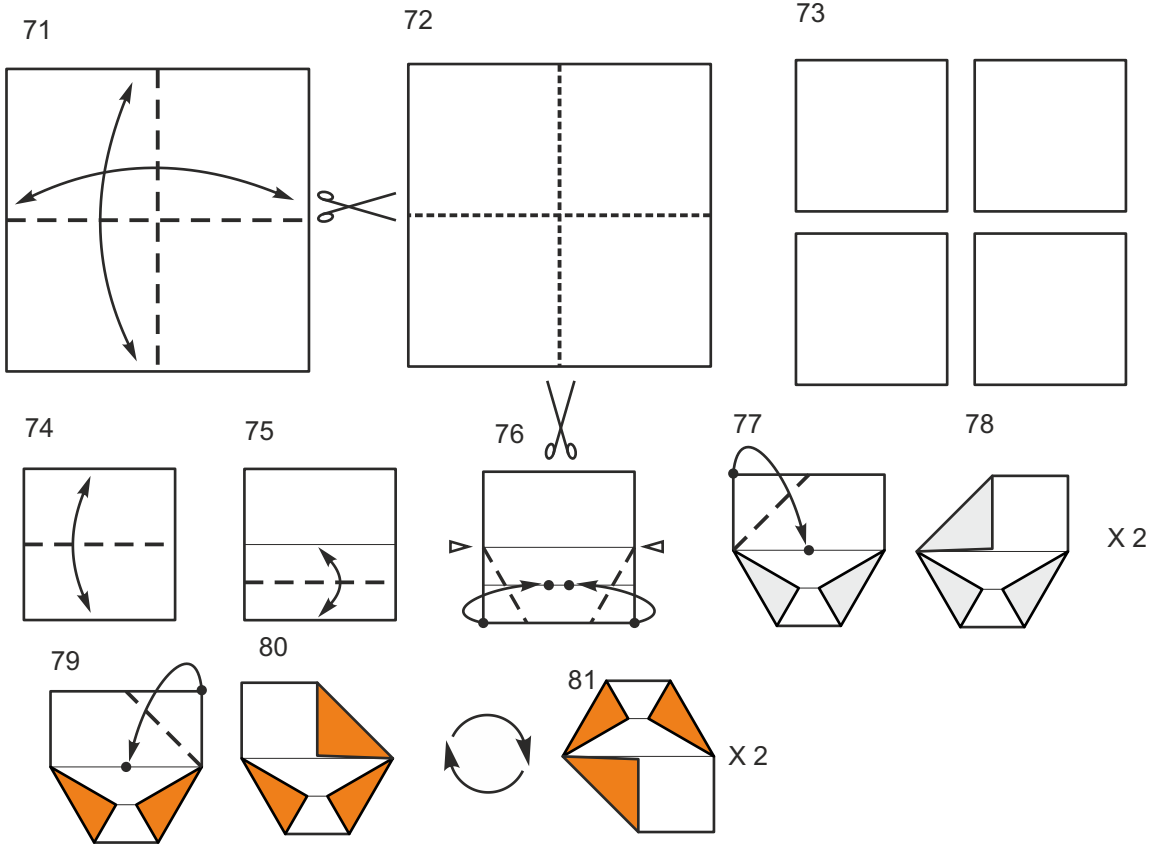

Inserimento giunti nella tessera quadrata

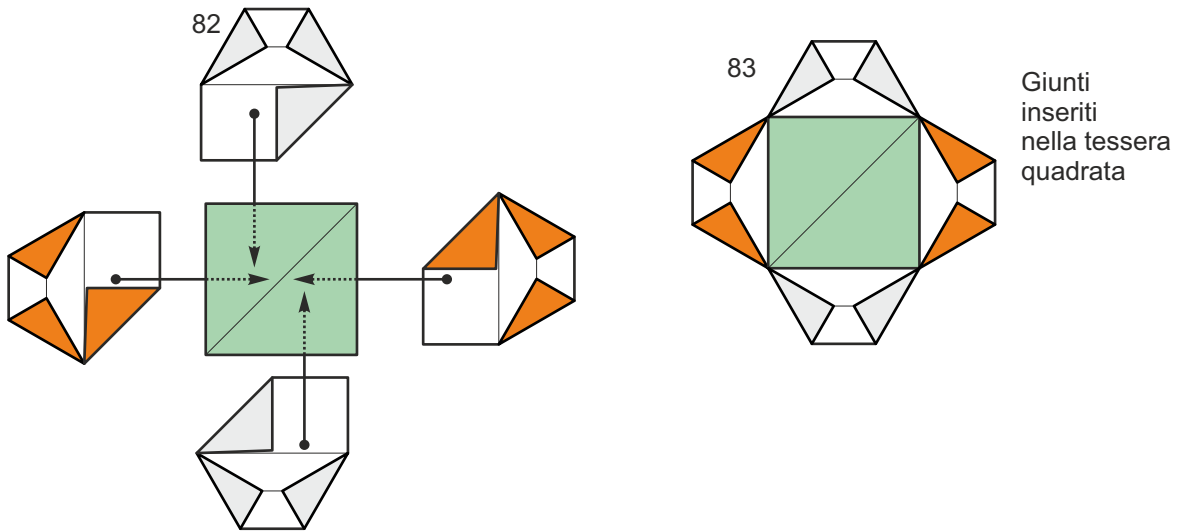

Unione della tessera quadrata con le tessere triangolari

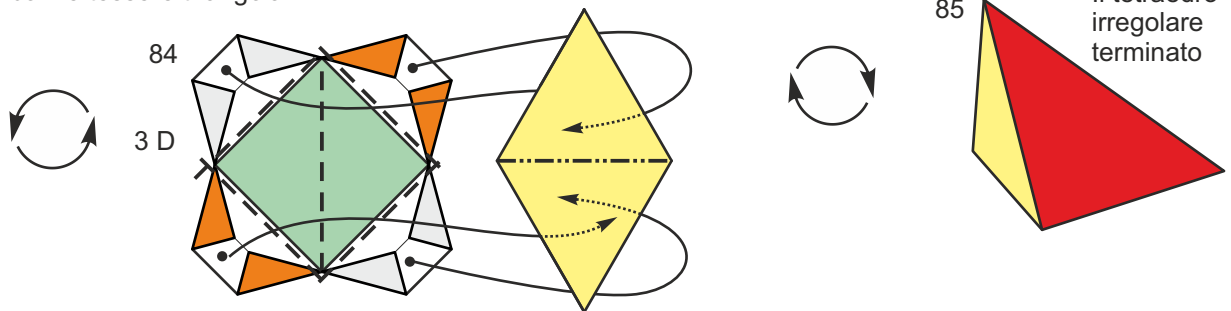

Il tetraedro irregolare terminato