

An Odd Duck

By Perry Bailey

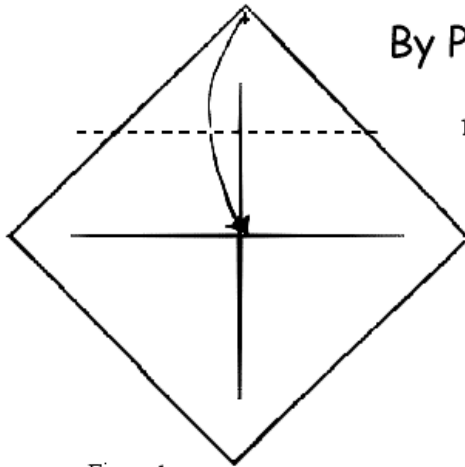

Figure 1

1. Fold a square piece of paper in half diagonally first one way then the other. Next fold the top corner marked A down to the center of the sheet.

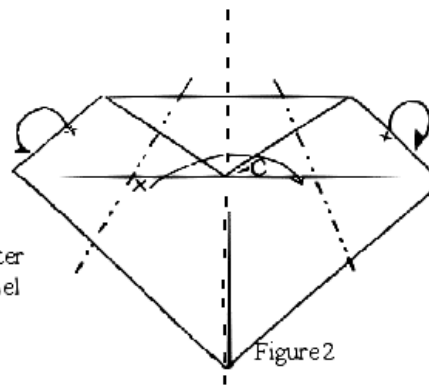

Figure 2

2. Mountain fold both sides into the center of the model then Valley fold the model in half.

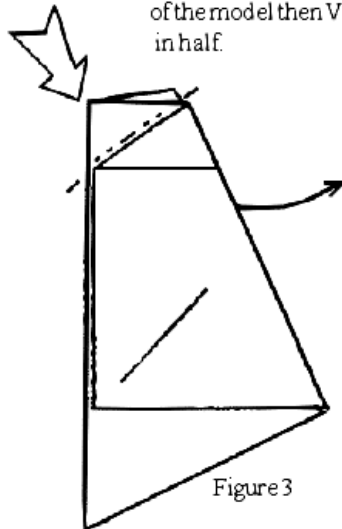

Figure 3

3. This looks more complicated than it is. You push in on the part where the big arrow is, in a sort of reverse fold, while simultaneously reaching inside of the model and pulling out the flap inside giving you figure 4.

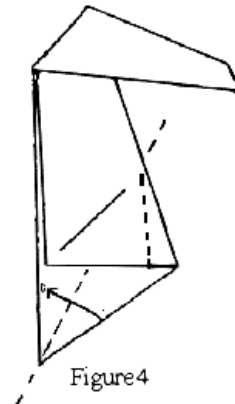

Figure 4

4. At this point fold up the sides as shown in the diagram, this is just like in the fish base.

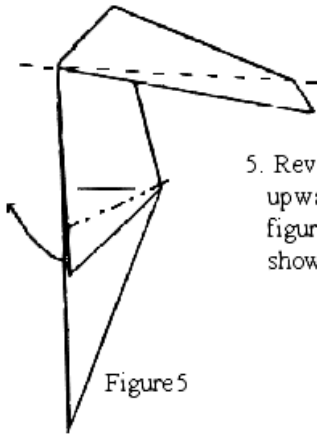

Figure 5

5. Reverse fold the top part of the model upward to give you the effect seen in figure 6. Then petal fold the flaps as shown in the diagram.

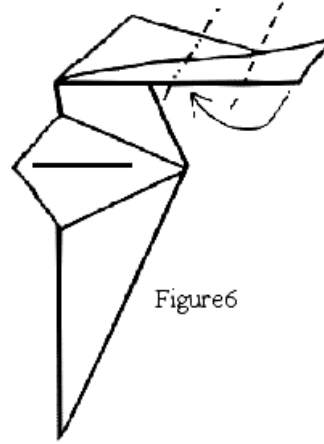

Figure 6

6. Reverse fold the nose in then back out again, creating the head as seen in figure 7.

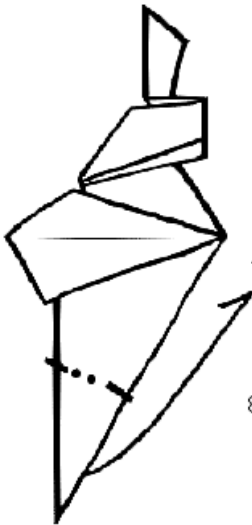

Figure 7

7. reverse fold the body upward to create the feet.

8. fold the base of the model inward on the bottom, to eliminate the excess paper, and create the feet. Then do the same for the head.

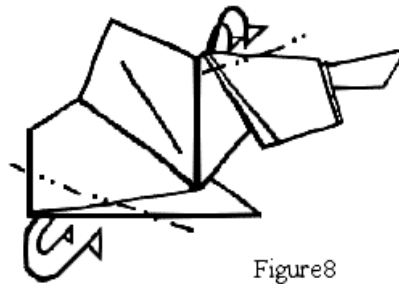
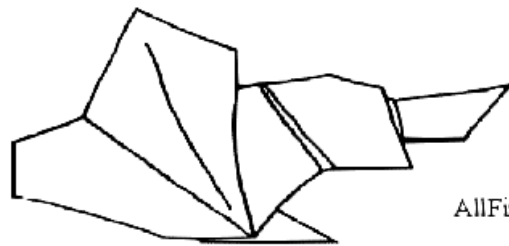

Figure 8



AllFinished

Figure 9