

Divisione in 17 parti uguali  
del lato corto di un rettangolo

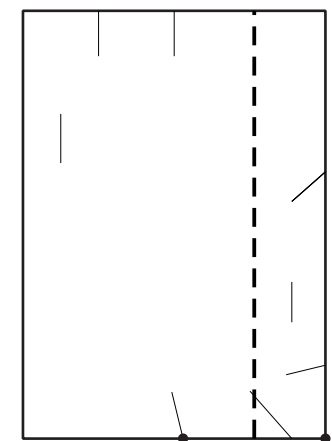

9

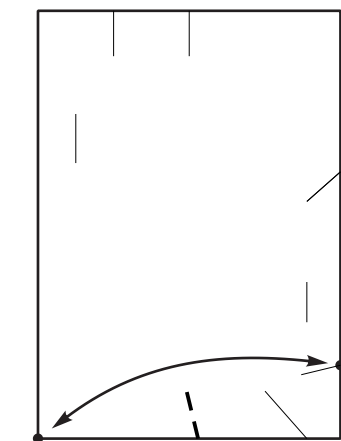
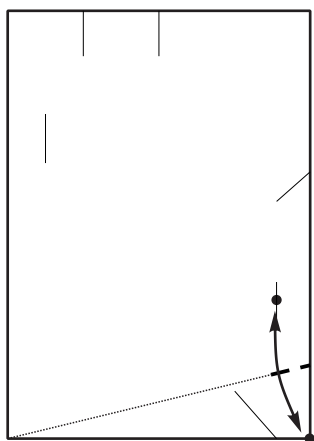
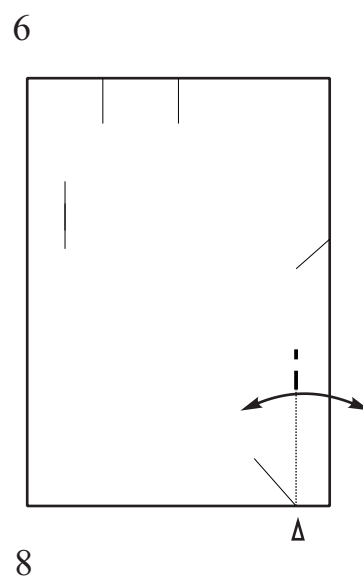
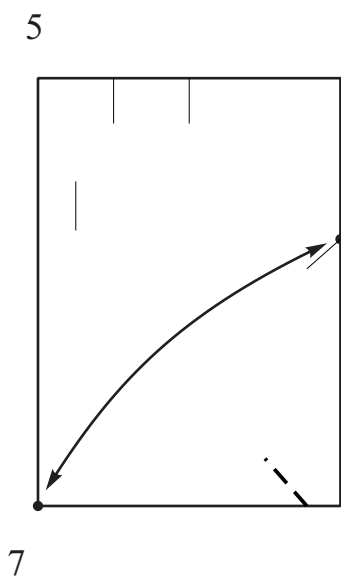
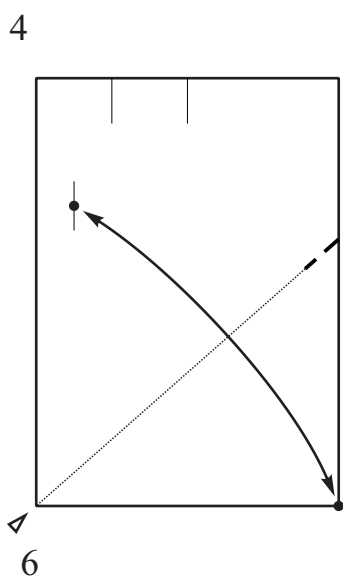
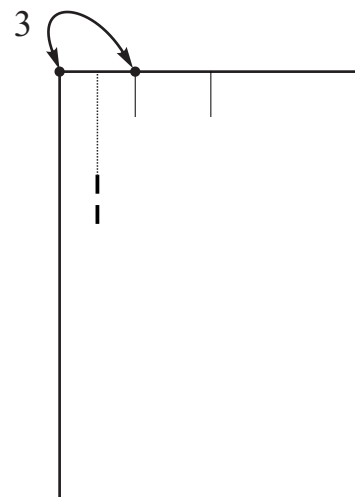
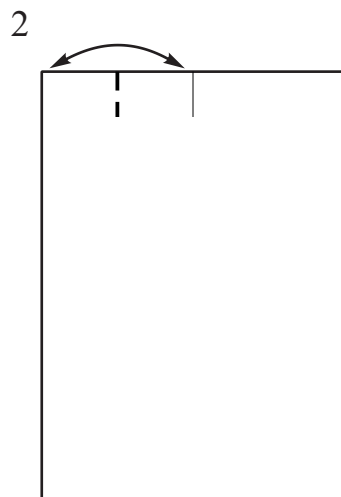
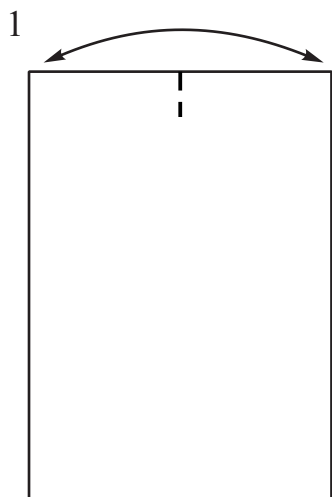
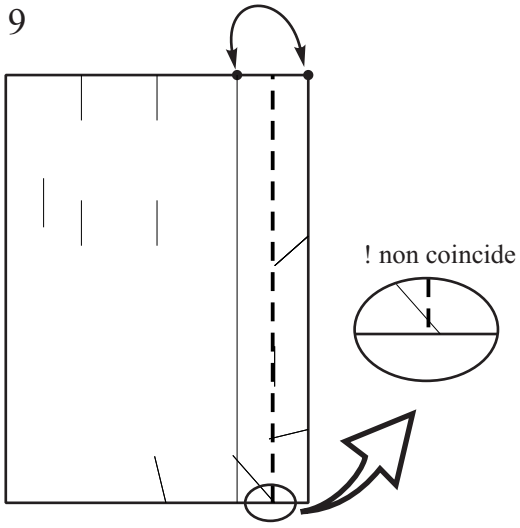

10

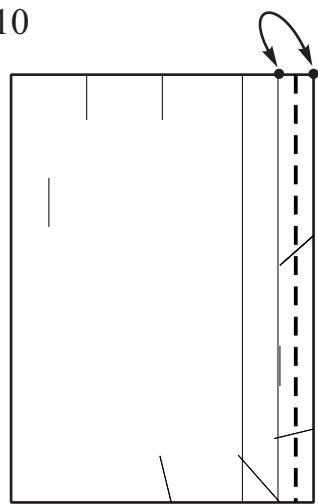

11

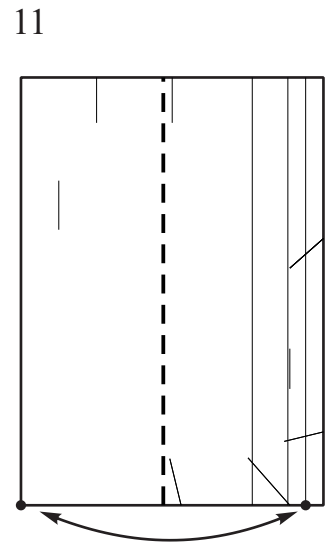

12

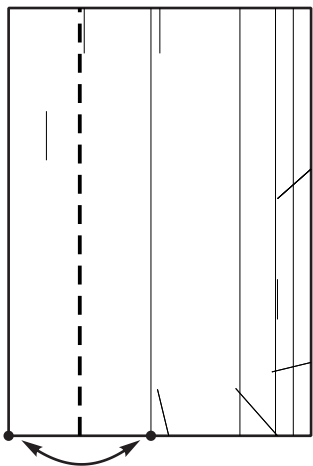

13

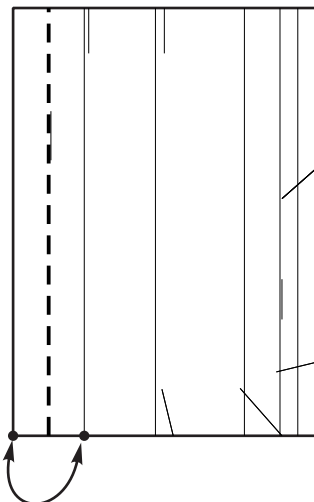

14

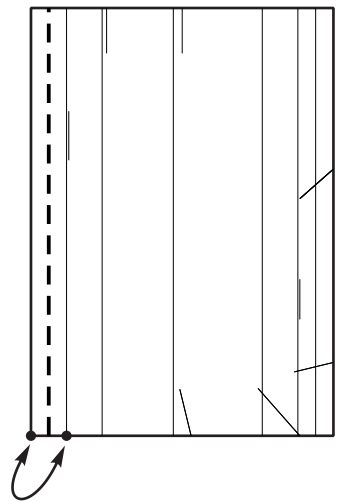

15

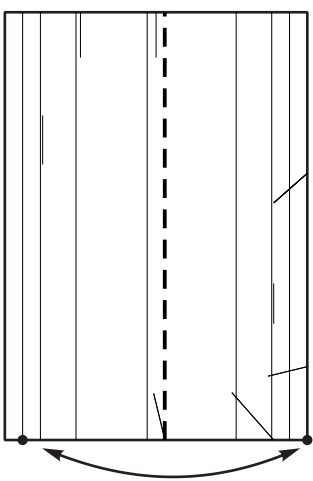

16

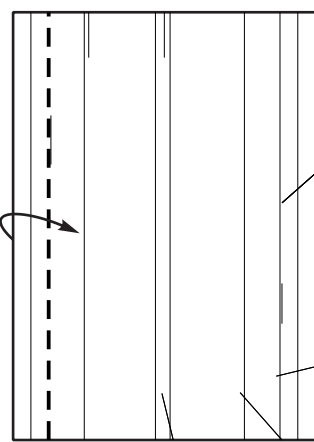

17

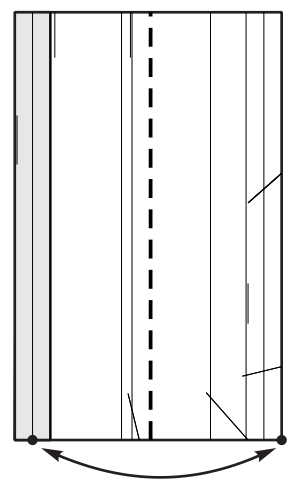

18

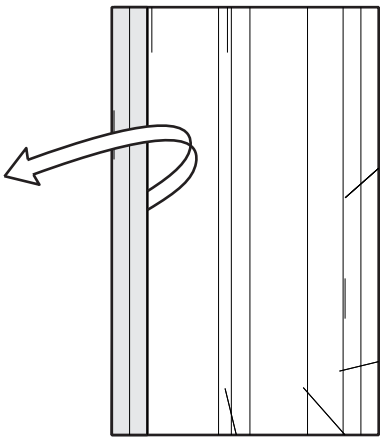

19

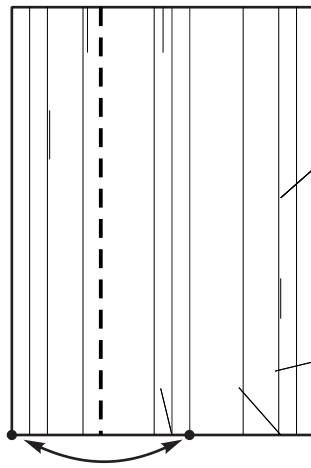

20

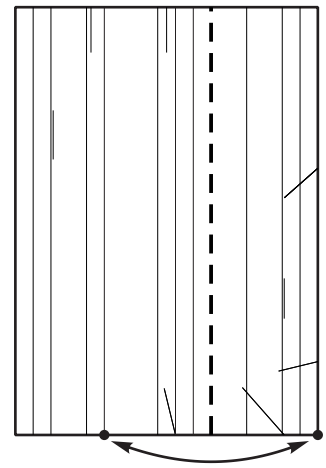

21

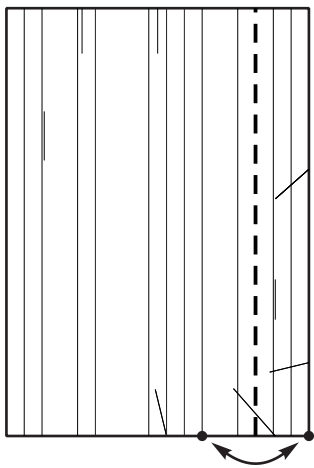

22

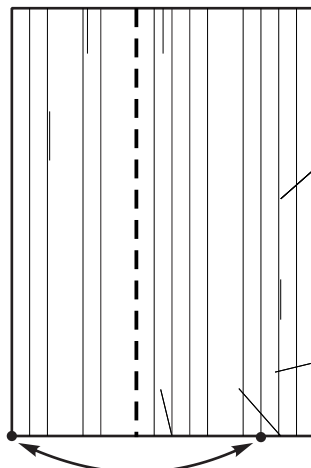

23

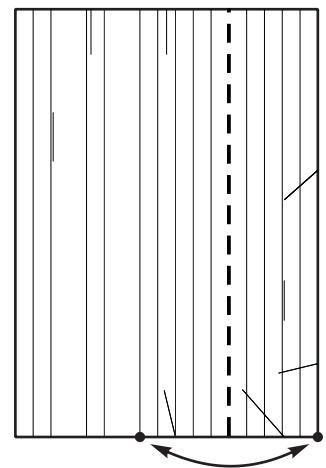

24

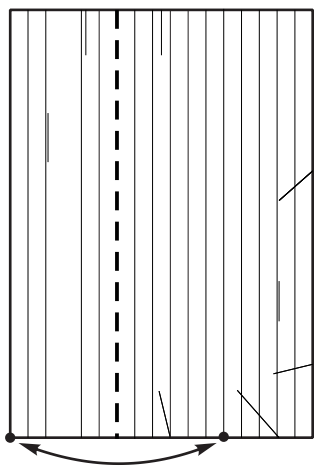

25

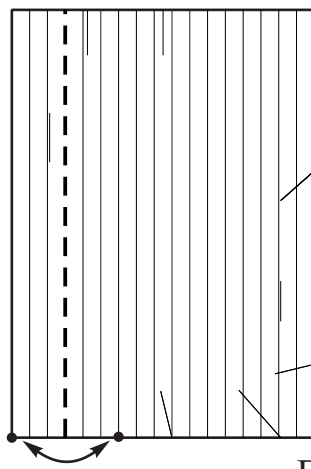

26

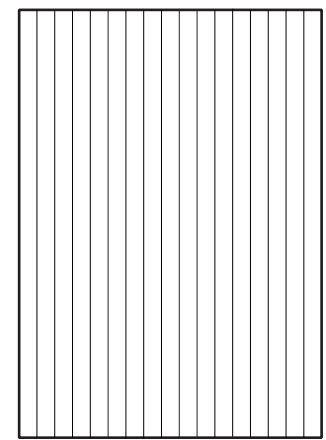

Divisione in 17 parti uguali  
del lato corto di un rettangolo  
terminata

Divisione in 17 parti uguali  
del lato lungo di un rettangolo

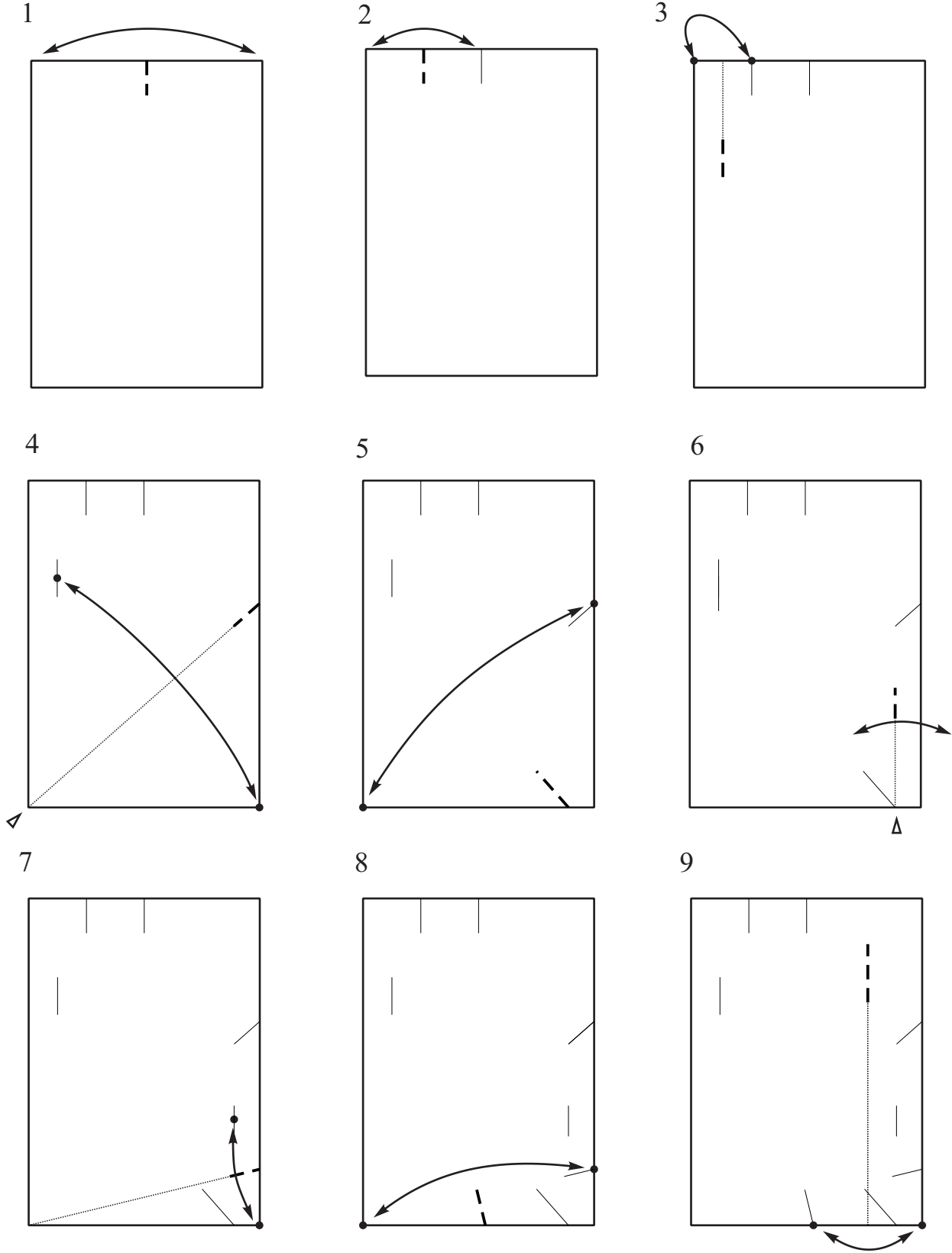

10

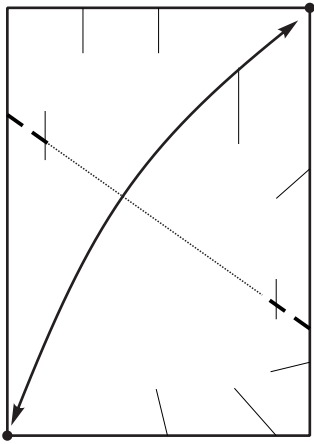

11

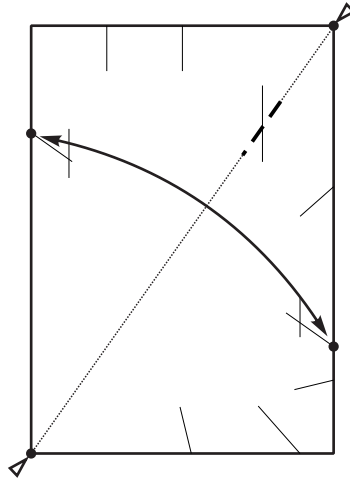

12

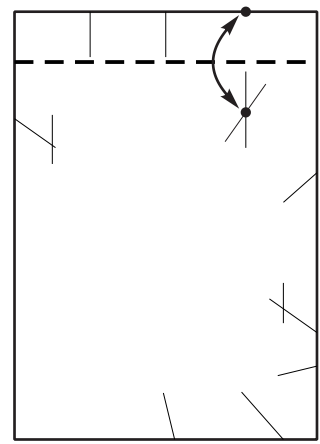

13

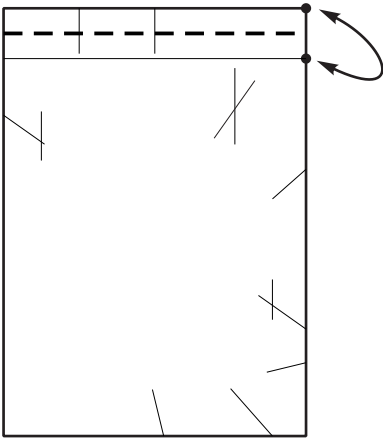

14

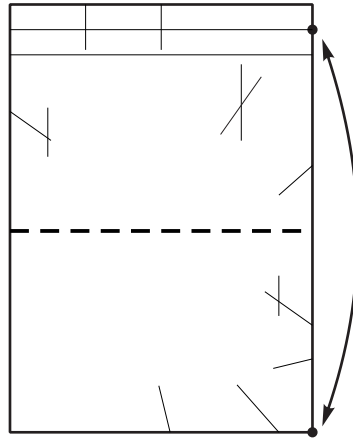

15

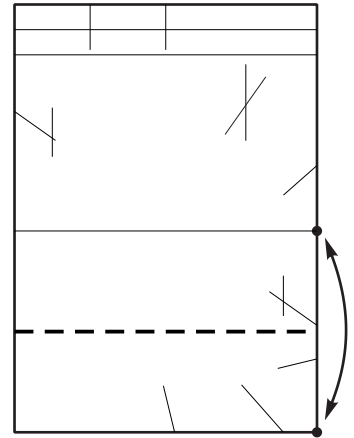

16

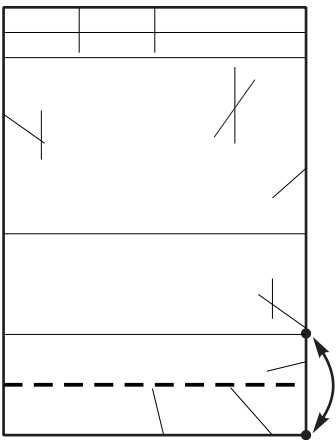

17

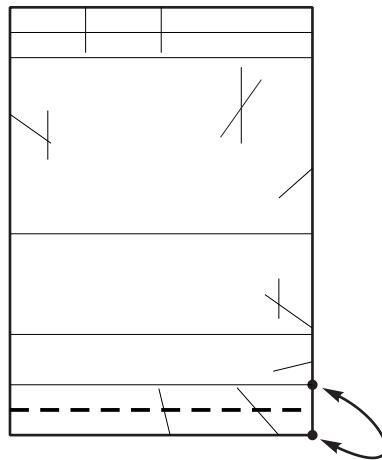

18

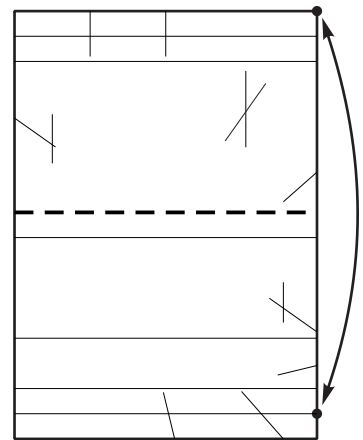

19

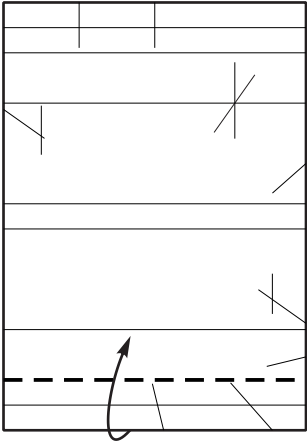

20

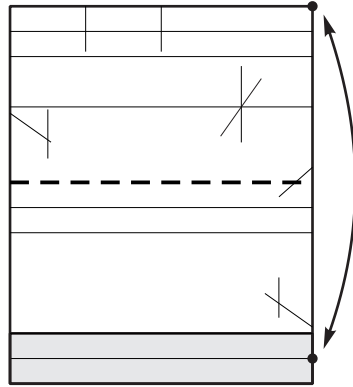

21

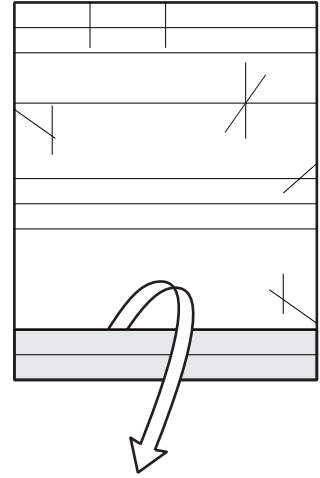

22

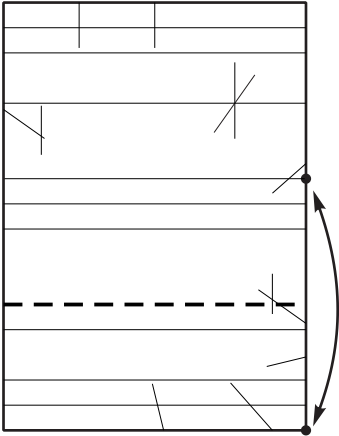

23

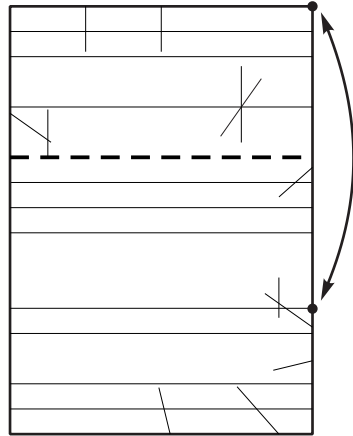

24

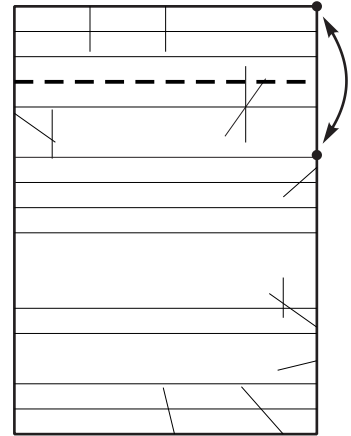

25

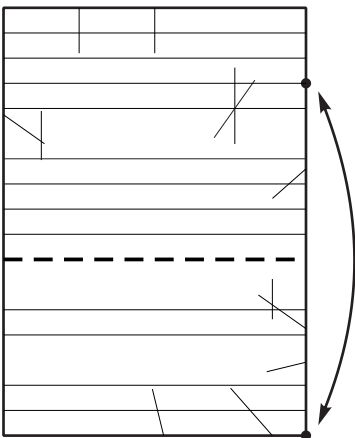

26

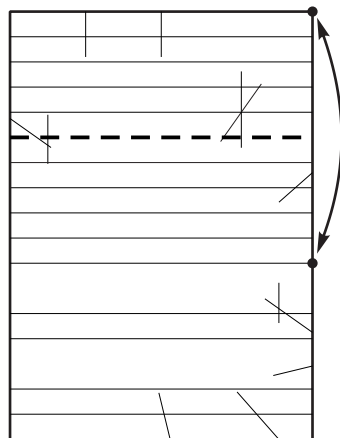

27

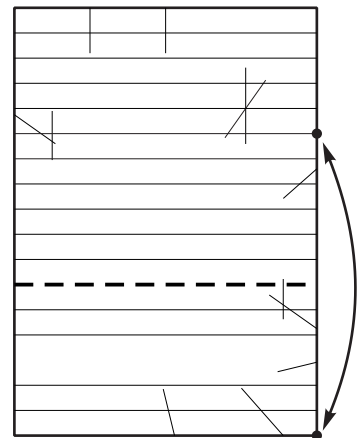

28

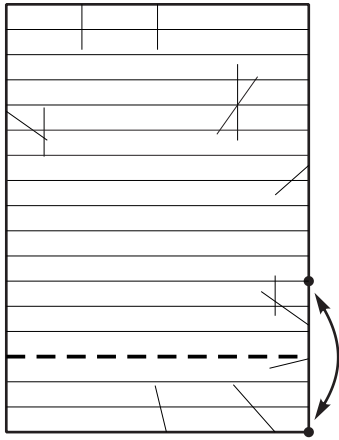

29



Divisione in 17 parti uguali  
del lato lungo di un rettangolo  
terminata