

Divisione in 15 parti uguali
del lato corto di un rettangolo

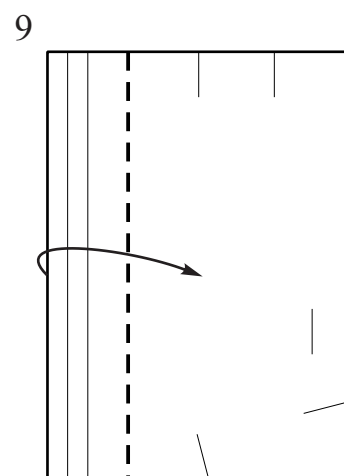

10

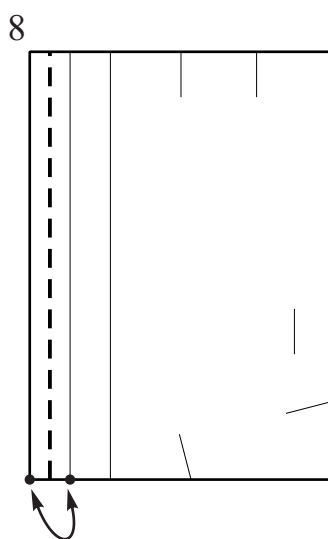
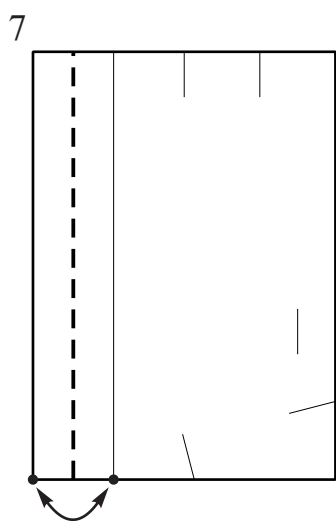
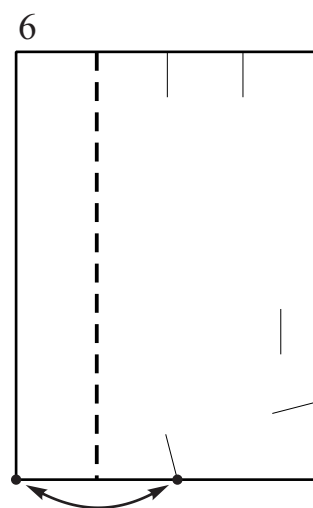
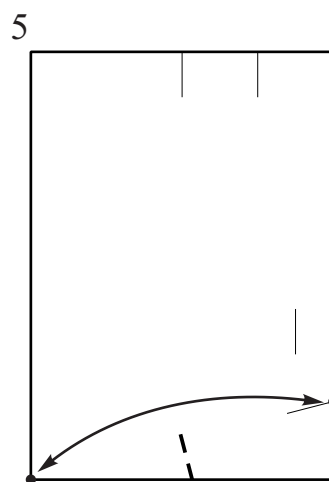
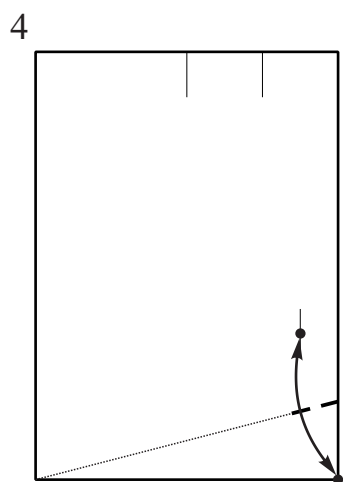
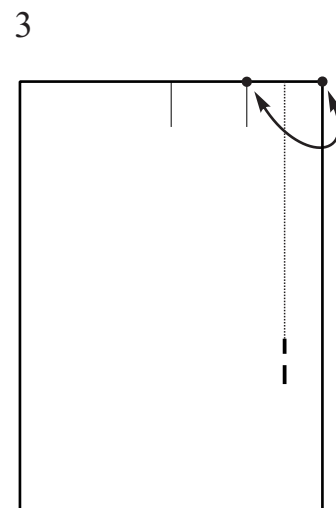
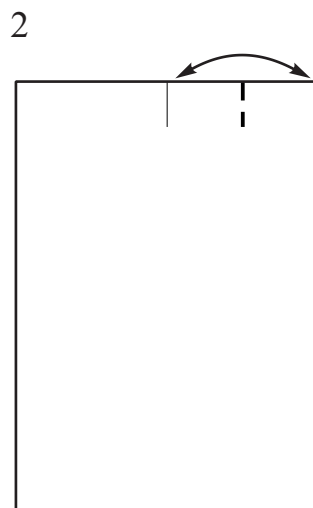
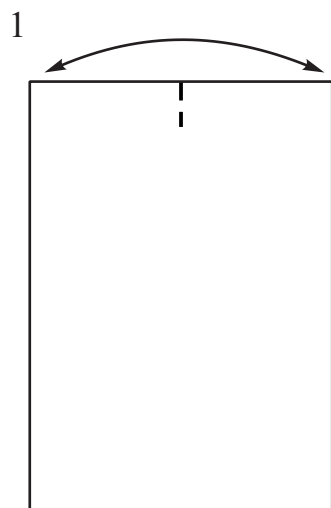
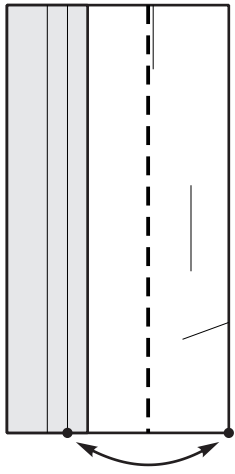

11

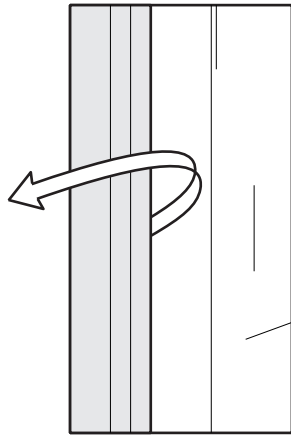

12

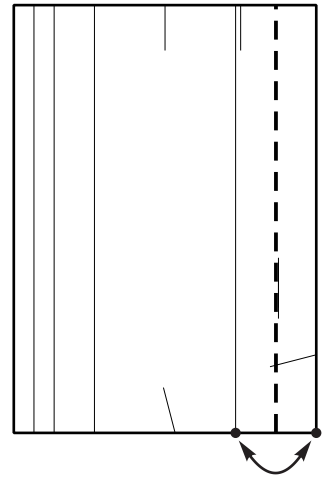

13

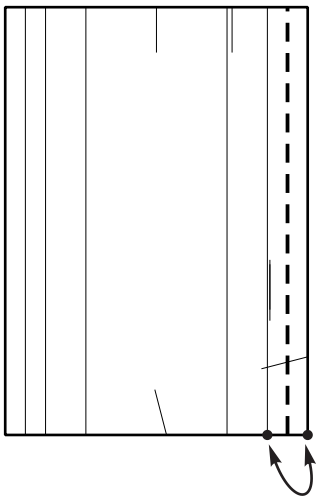

14

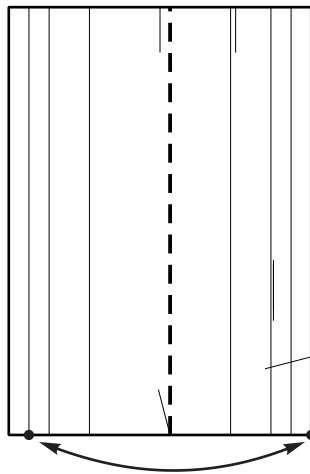

15

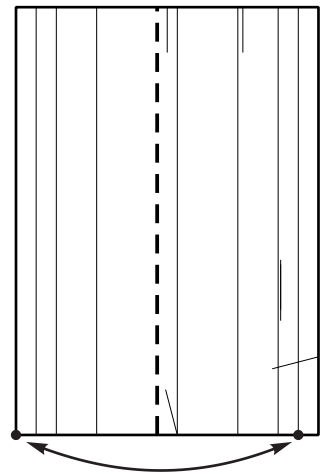

16

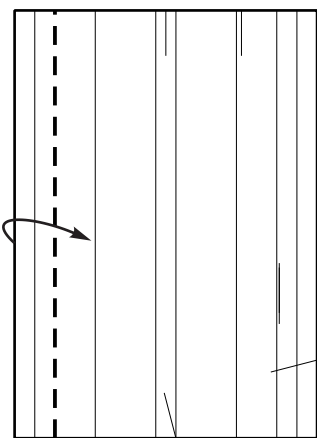

17

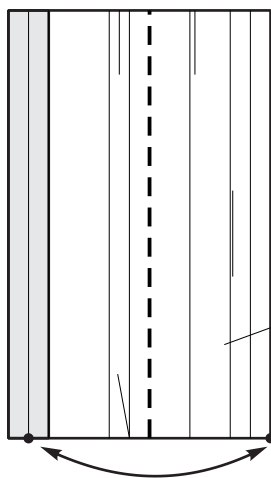

18

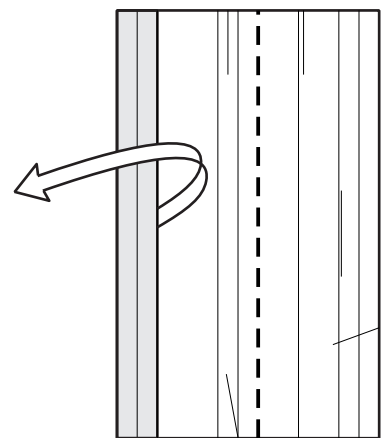

19

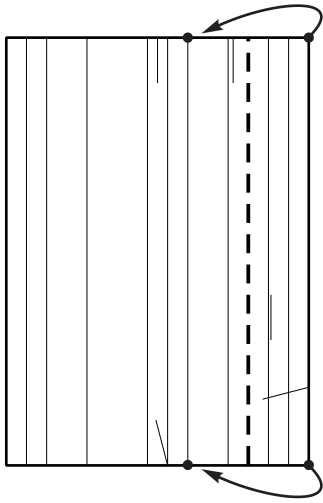

20

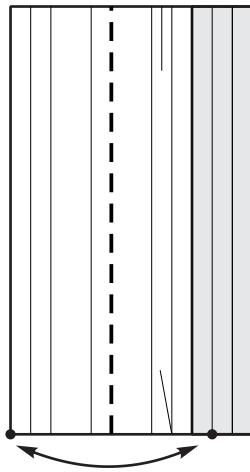

21

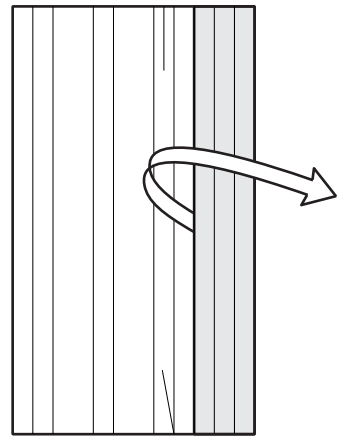

22

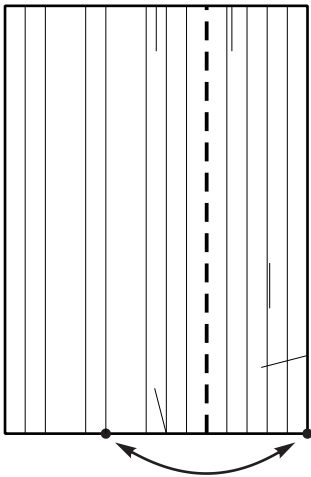

23

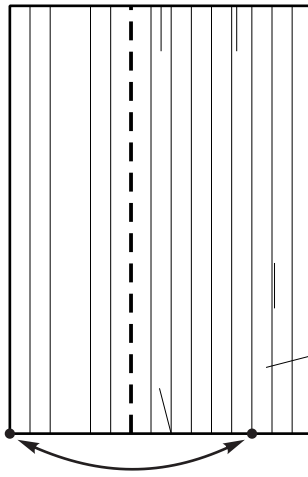

24

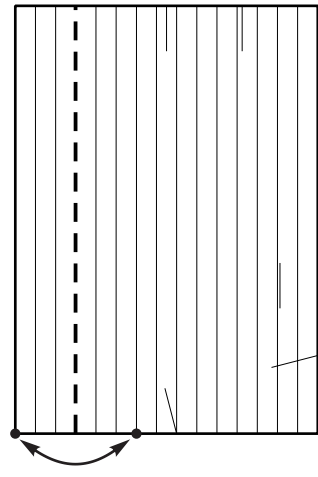

25

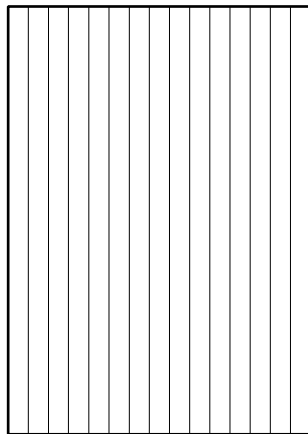

Divisione
terminata

Divisione in 15 parti uguali
del lato lungo di un rettangolo

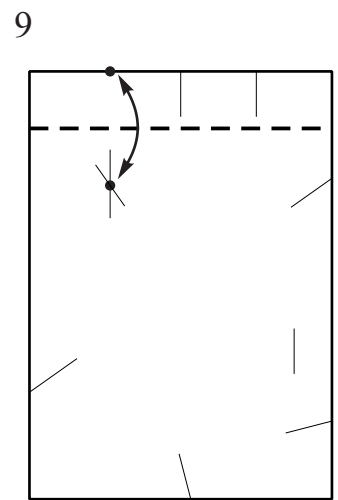
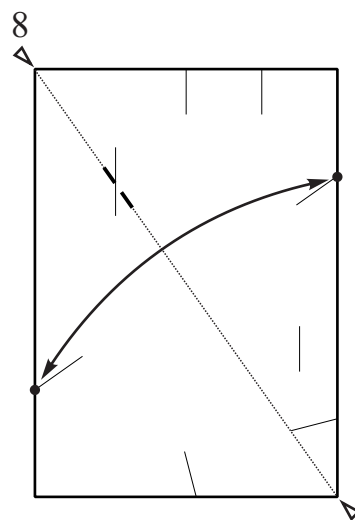
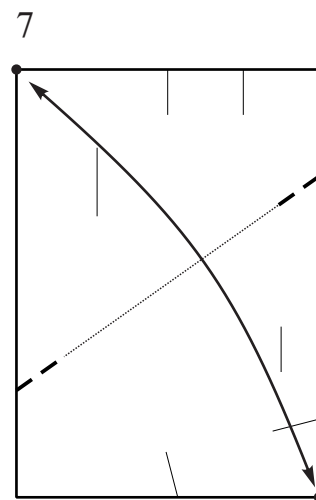
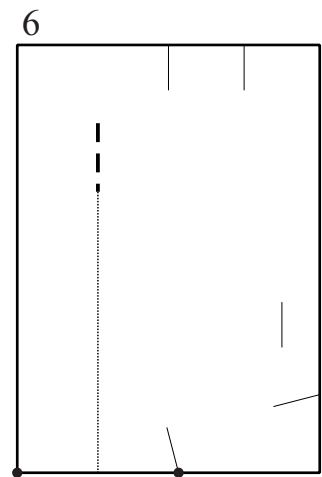
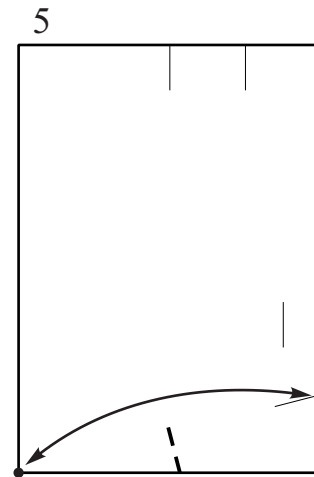
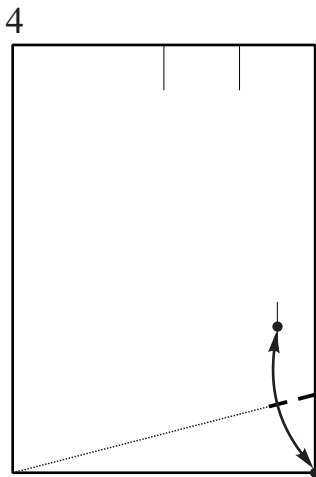
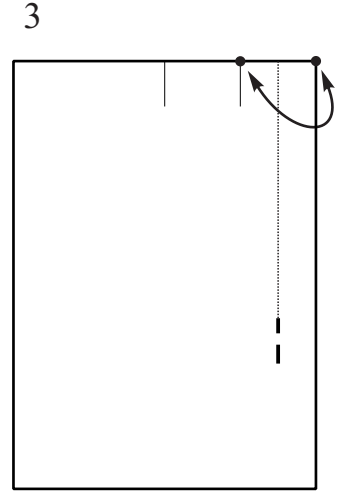
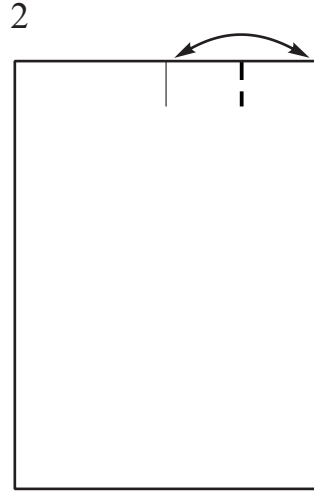
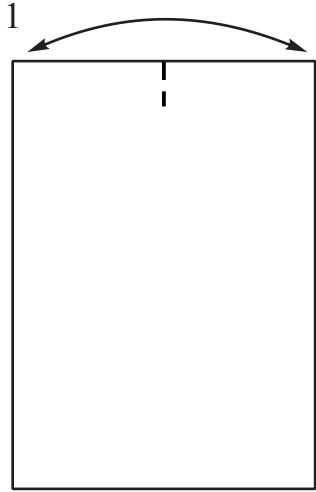

10

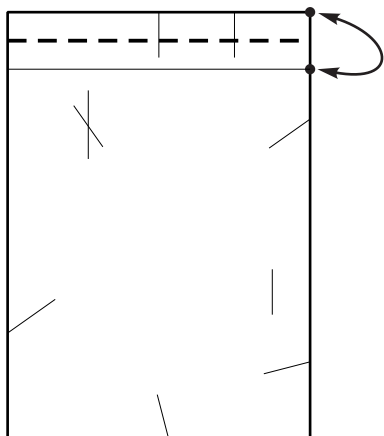

11

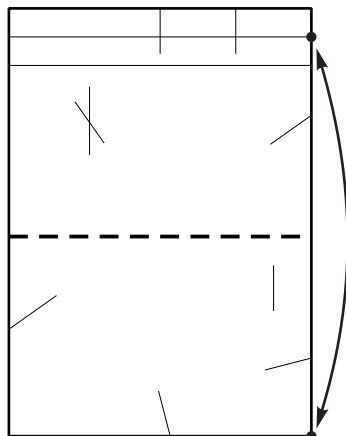

12

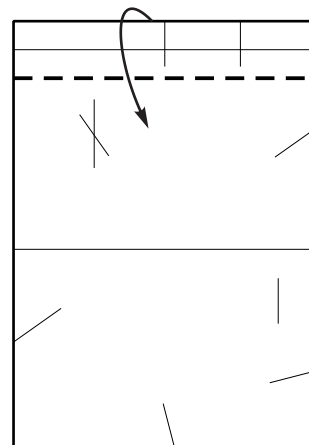

13

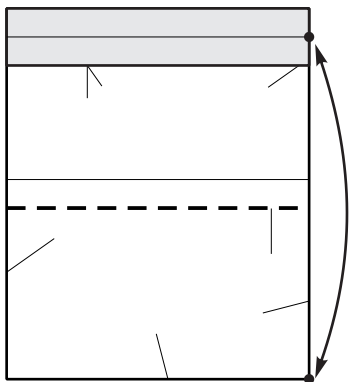

14

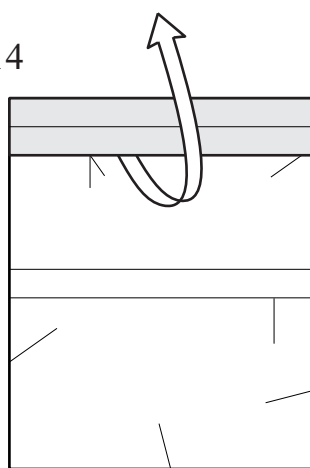

15

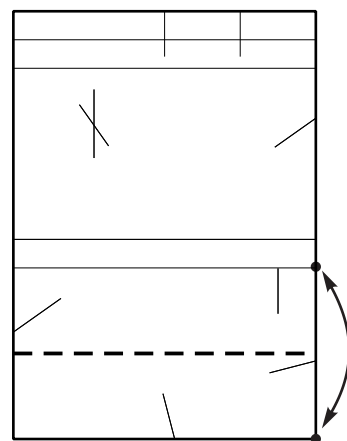

16

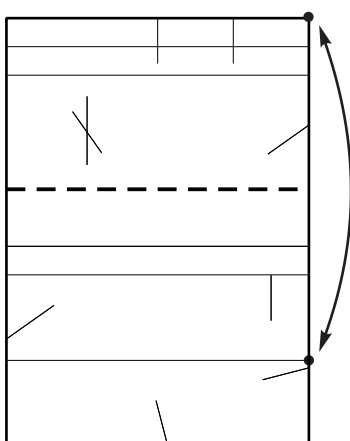

17

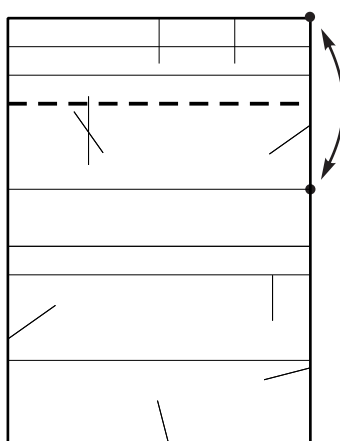

18

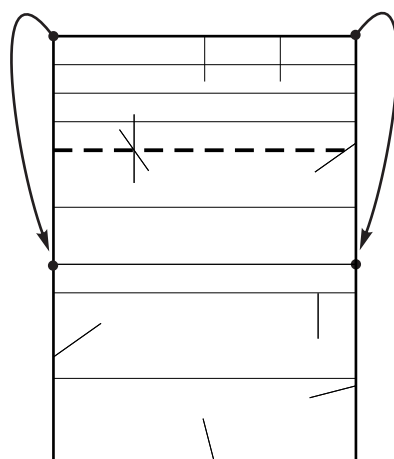

19

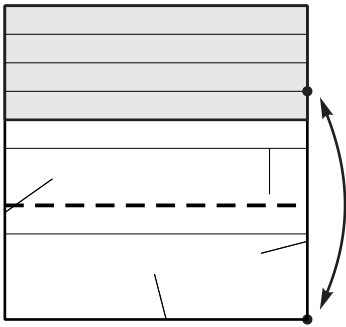

20

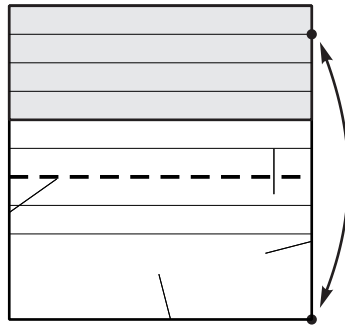

21

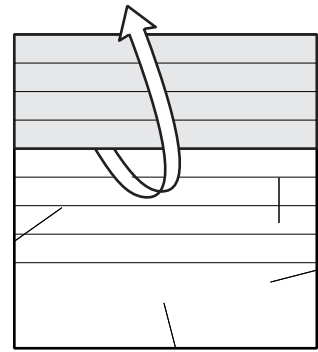

22

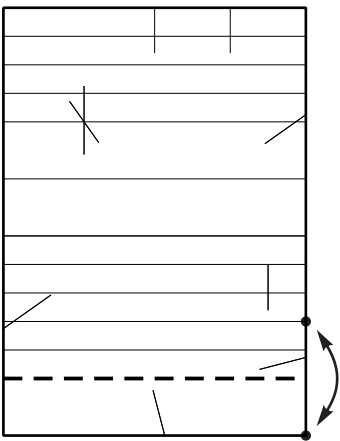

23

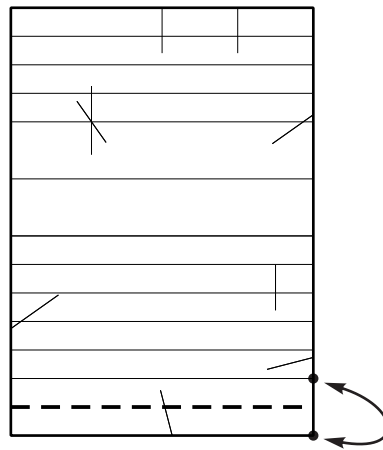

24

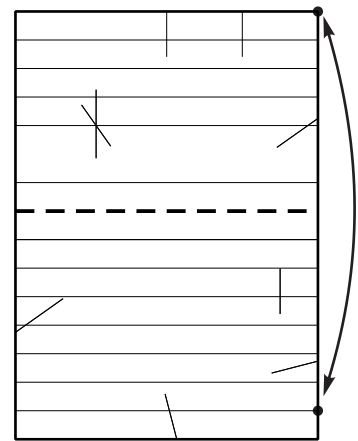

25

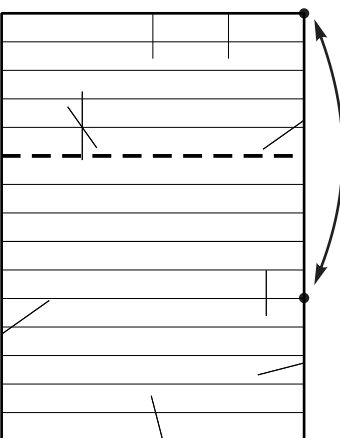

26

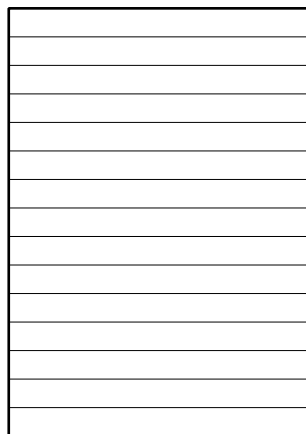

Divisione
terminata