

ORICHIMICA

Omaggio a Shuzo Fujimoto

Legame (giunto)

$1 \times 1\sqrt{2}$

(A 4 o equivalente)

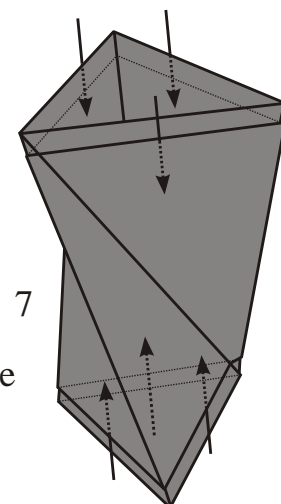
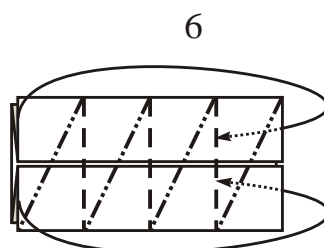
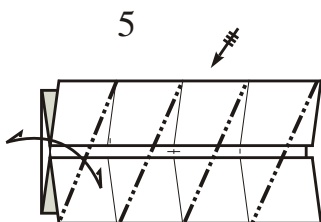
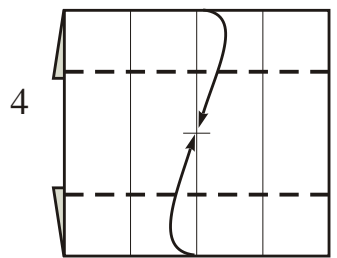
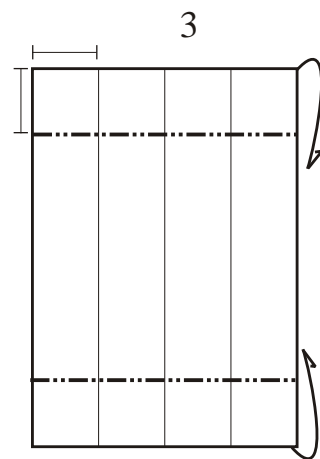
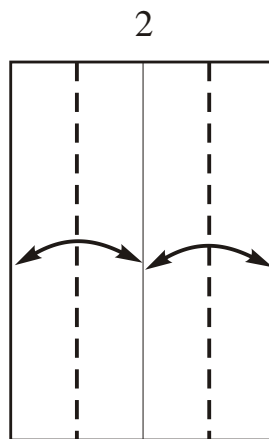
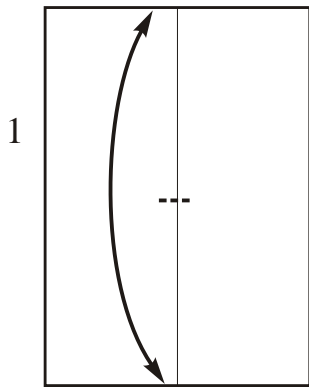

Legame
finito

Carbonio (atomo modulare)

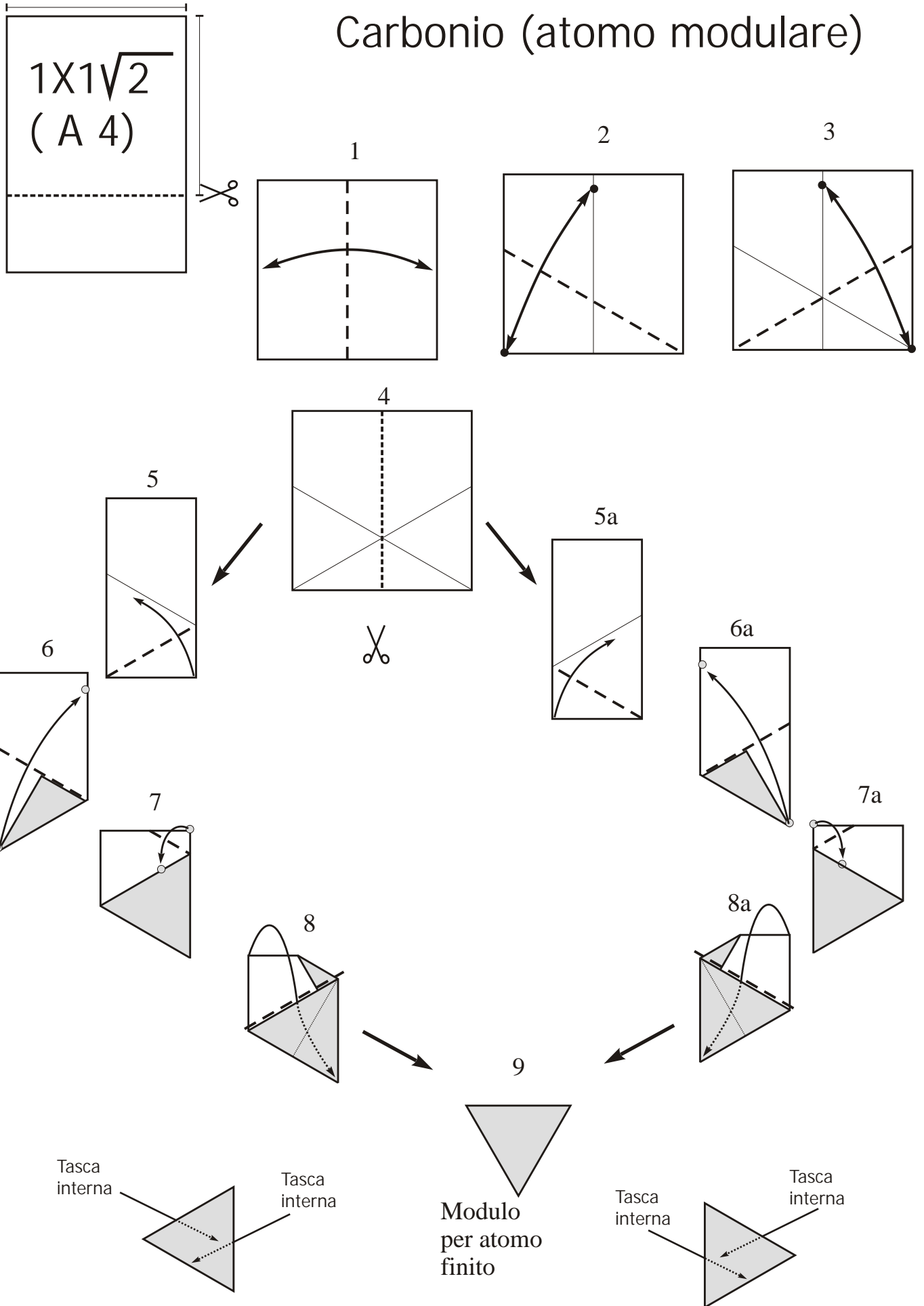

Coperchio di chiusura catena (opzionale)

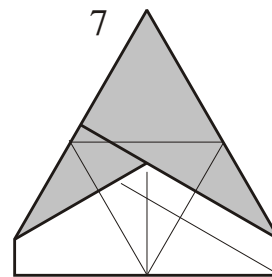
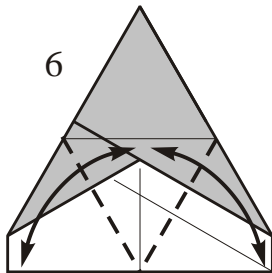
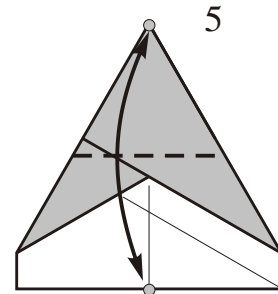
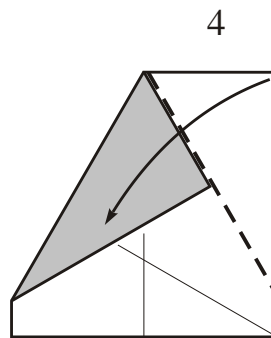
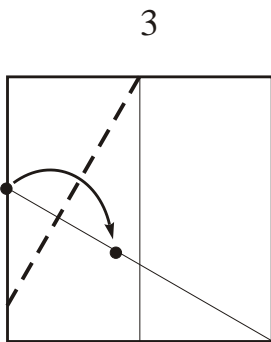
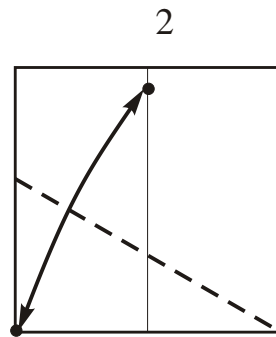
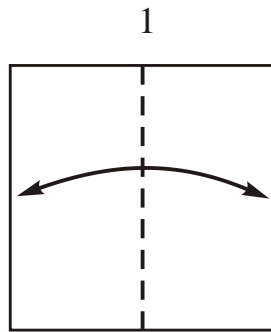
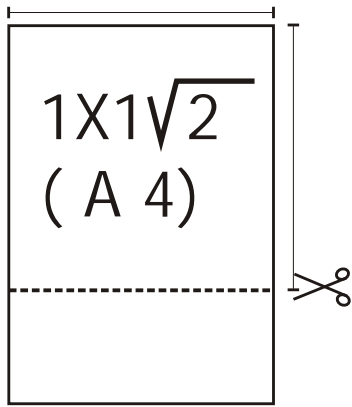

Coperchio di
chiusura finito

Tappo di chiusura per atomo modulare

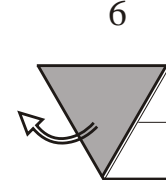
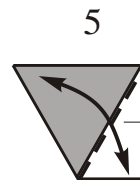
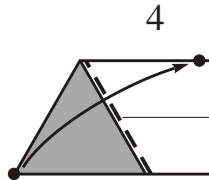
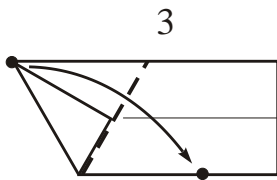
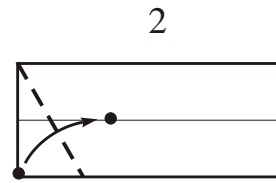
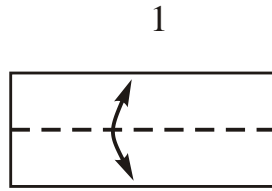
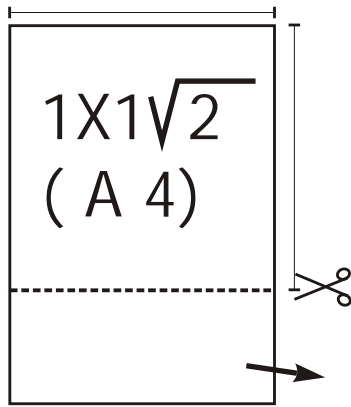

Ripetere
3 - 4 - 5 - 6

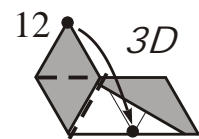
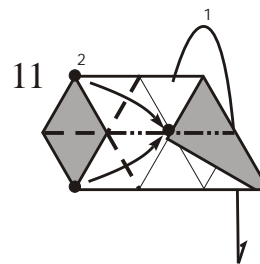
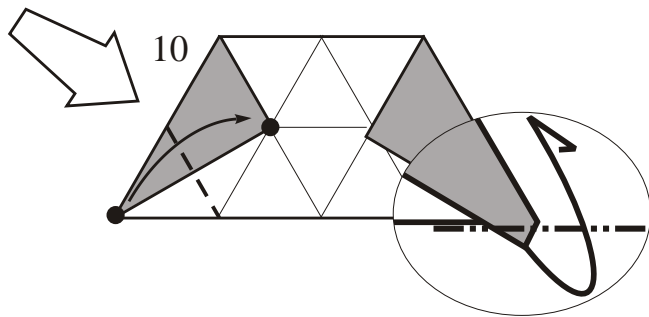
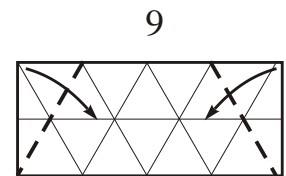
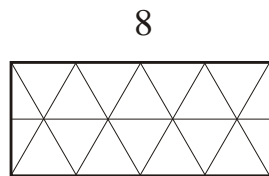
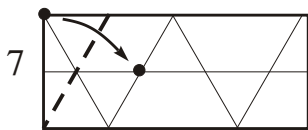

14 Tappo finito

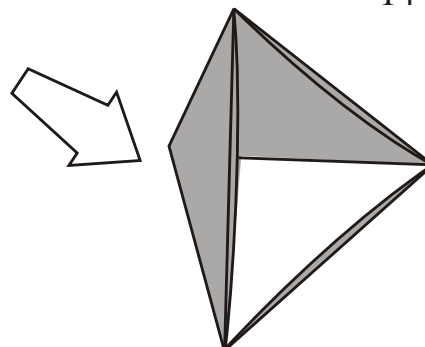
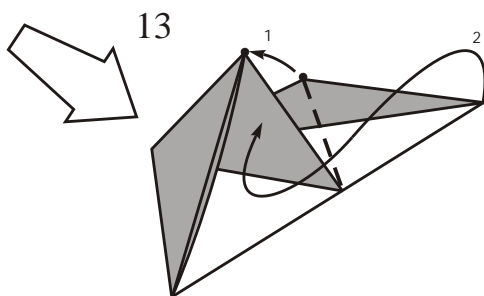

Poiché un lato esterno risulta di colore inverso è bene usare un foglio MONOCOLORE.

Montaggio di una catena

1

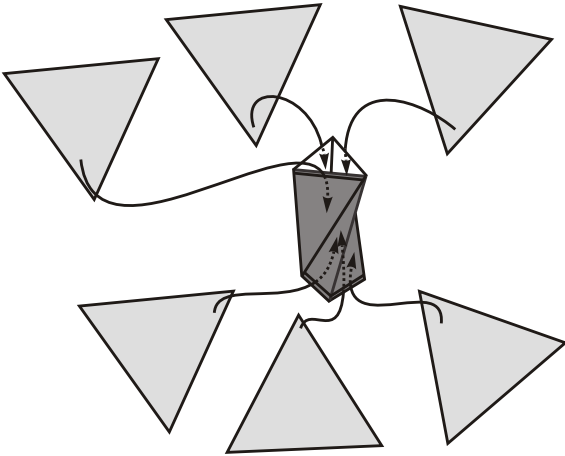

2

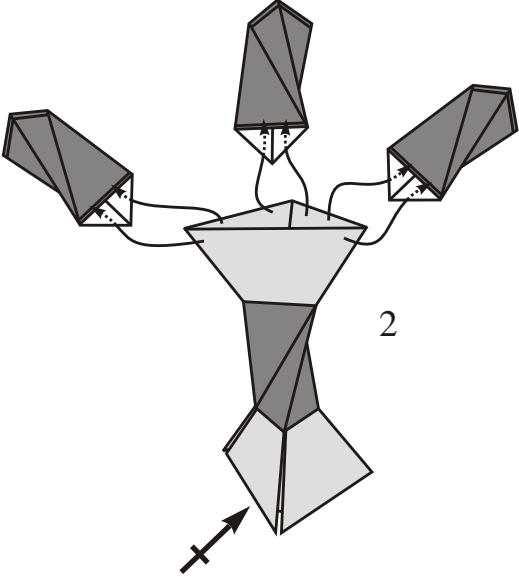

3

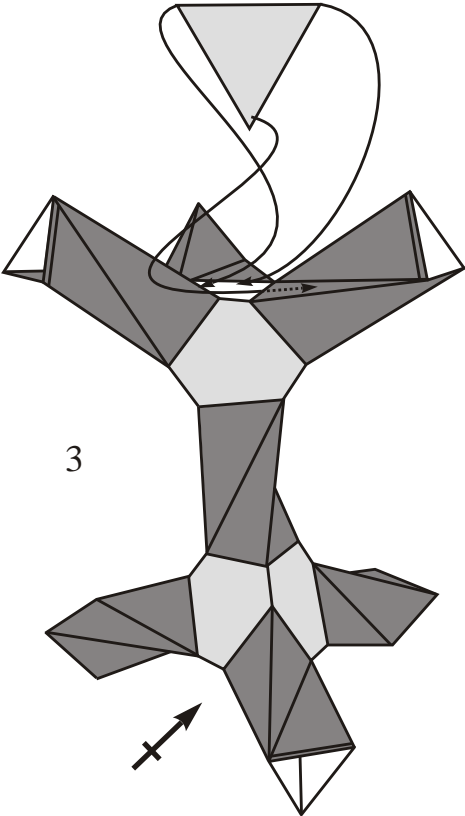

4

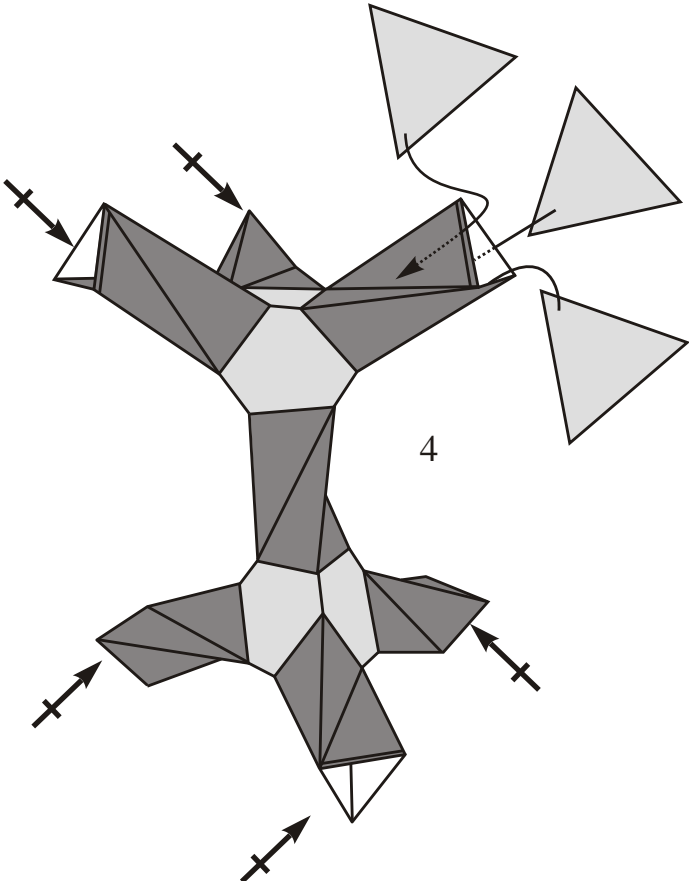

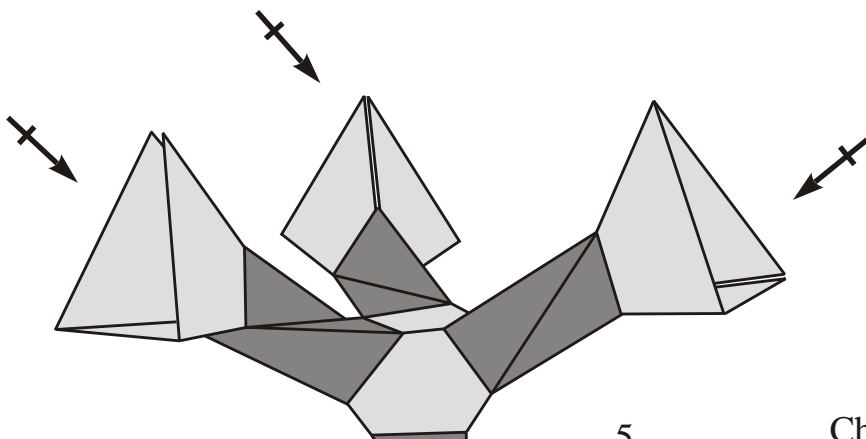

5

Chiusura degli atomi
con il coperchio (facoltativa)

(Con la chiusura NON è più
possibile proseguire nella catena.)

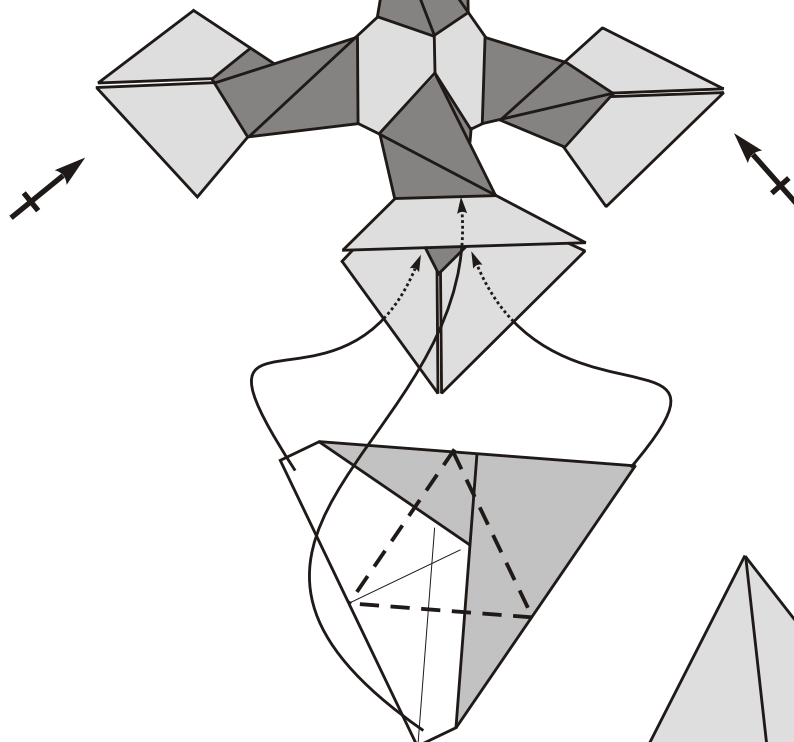

Un tipo di
catena finito.

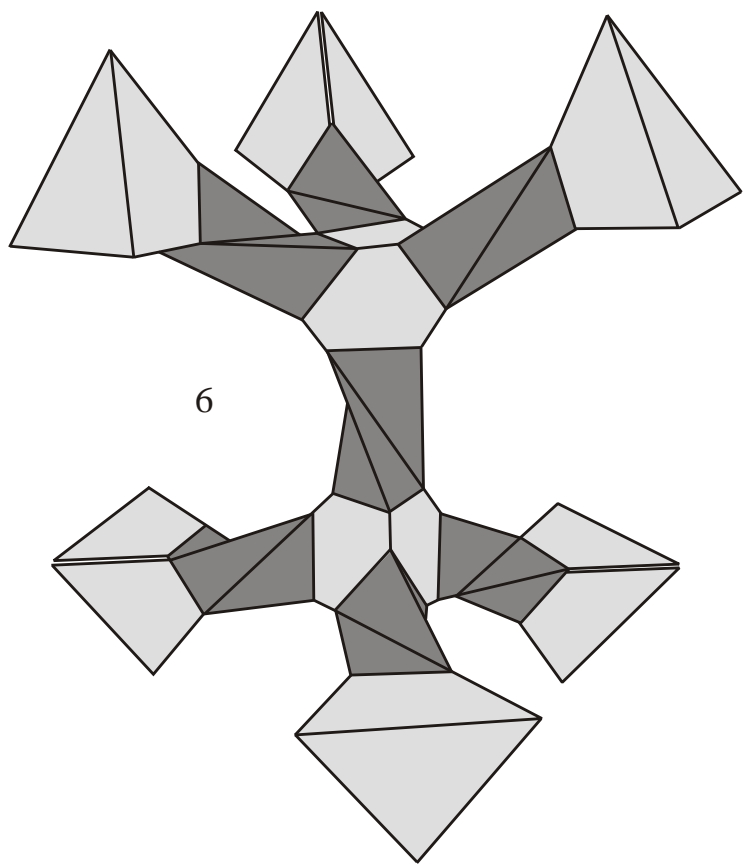

6

E' possibile anche uno sviluppo ORIZZONTALE della struttura.

Per comporre questa figura sono necessari:

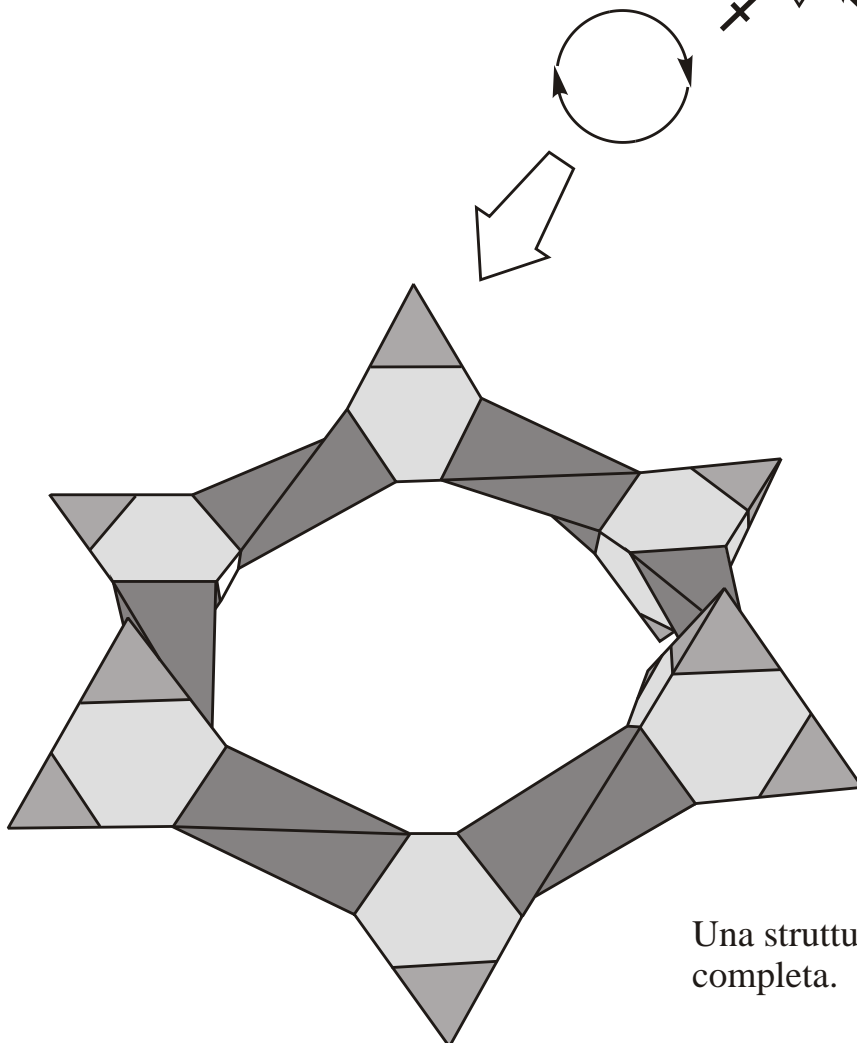
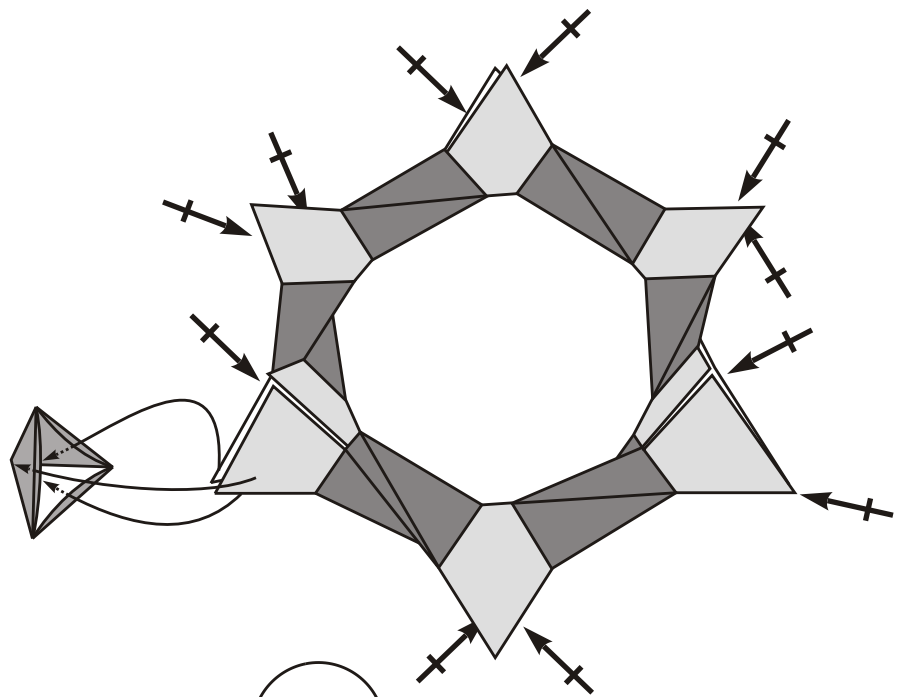

Una struttura a "corona"
completa.

Combinando lo sviluppo ORIZZONTALE e VERTICALE è possibile ottenere figure complesse.

La figura qui sotto è composta da:

16 pezzi 

12 pezzi 

4 pezzi 

52 pezzi 

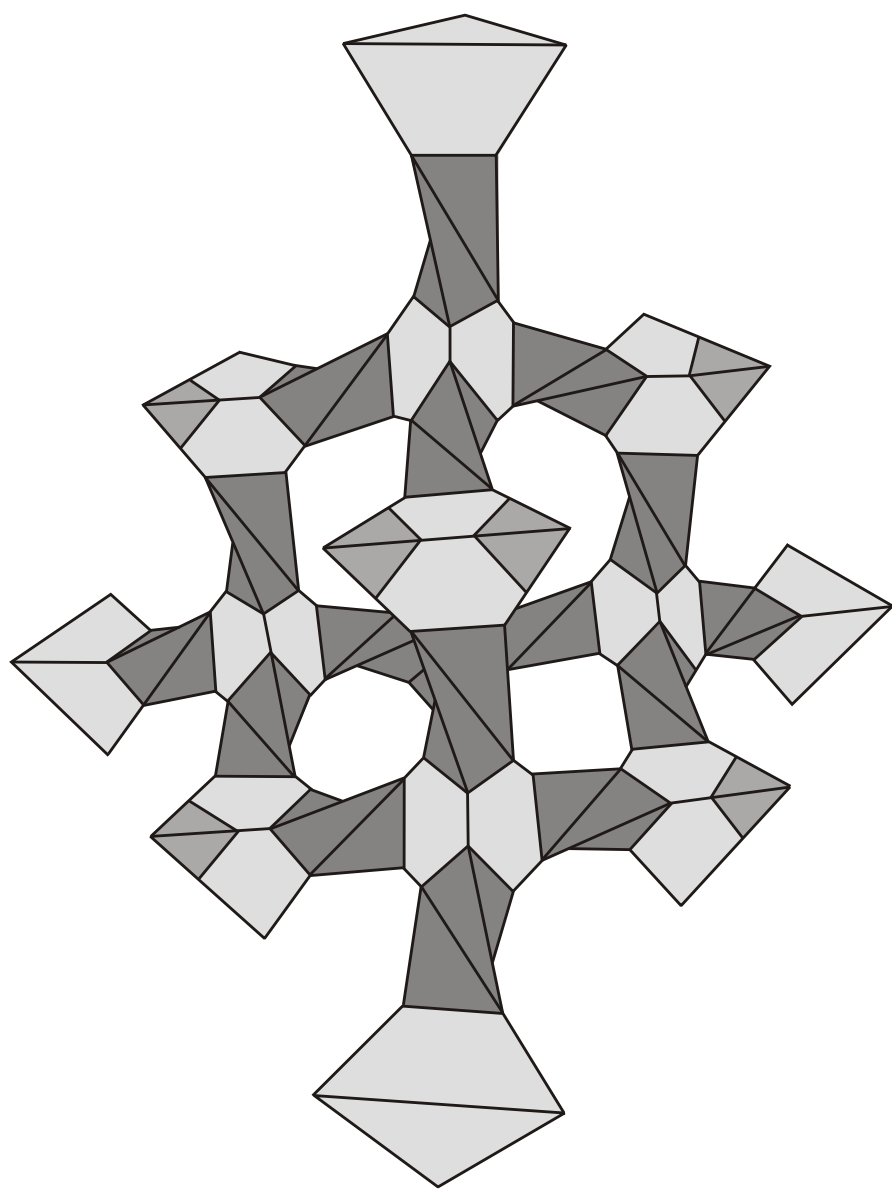

Molte altre figure sono comunque possibili.